

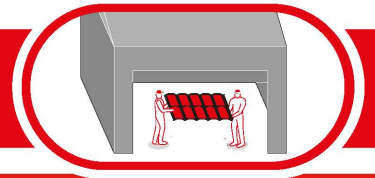

EKSKLUZYWNE POKRYCIA DACHOWE

Skrócona
instrukcja
montażu
blachodachówki
modułowej
Elektra, Liwia,
Mona, Petra
z kryciem w pasach
od lewej do prawej
www.regamet.pl





ELEKTRA duo

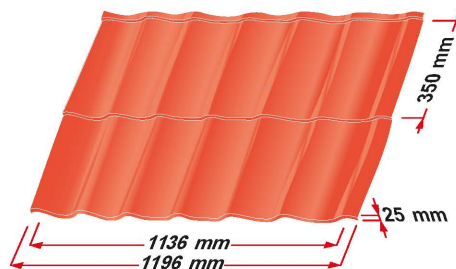

LIWIA duo

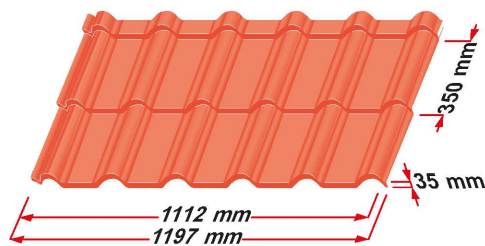

MONA duo

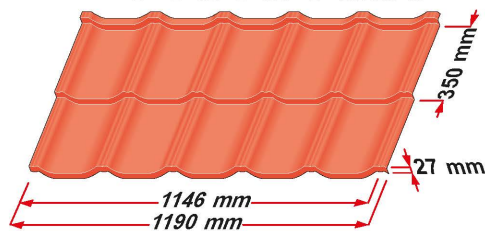

PETRA duo

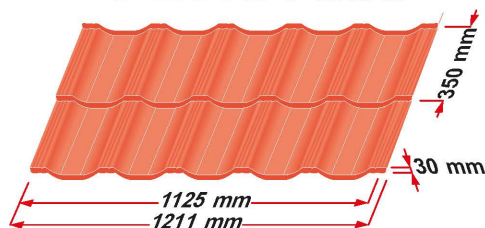

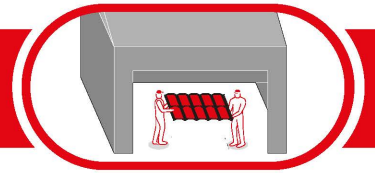

1

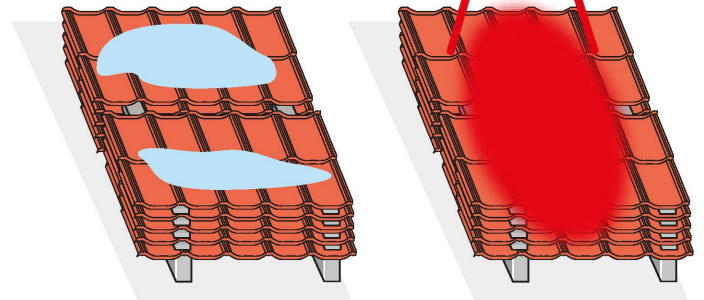
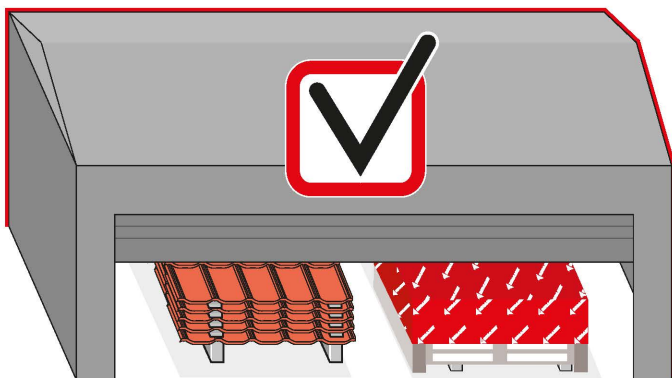
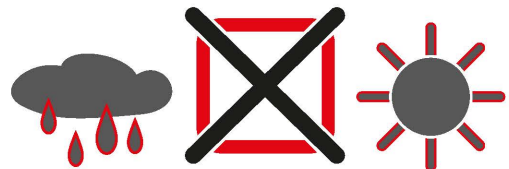
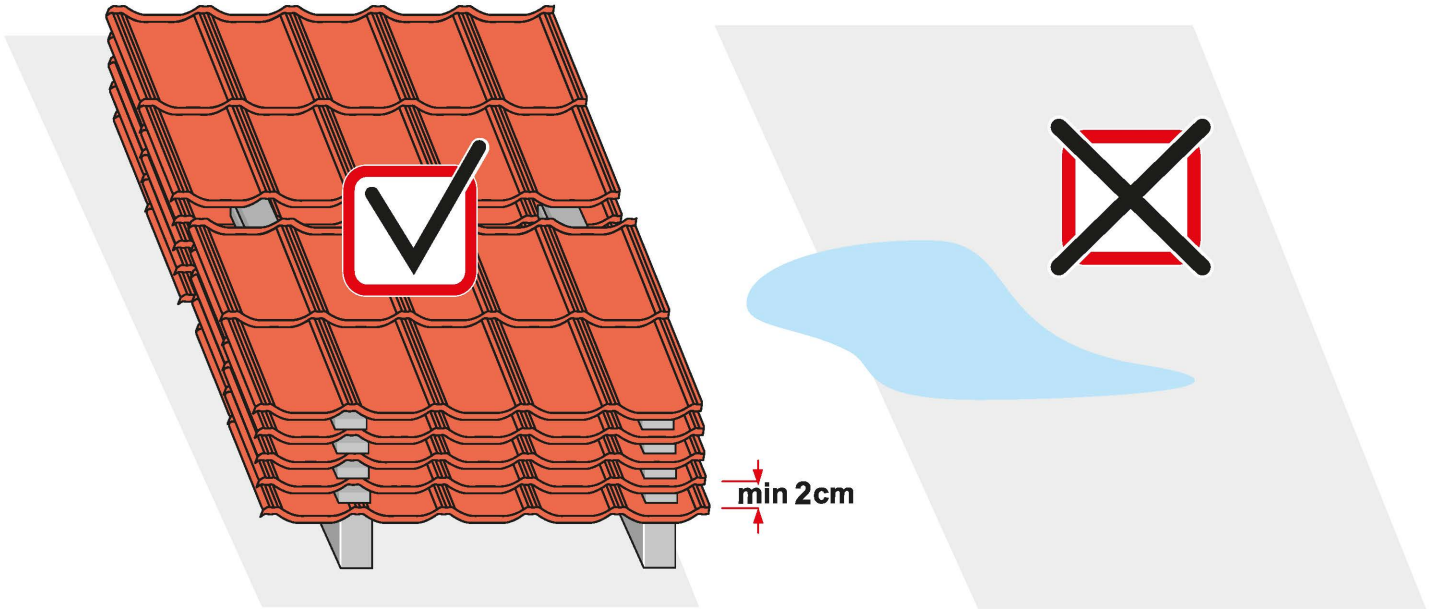

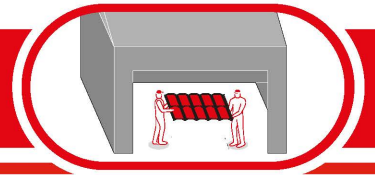

2

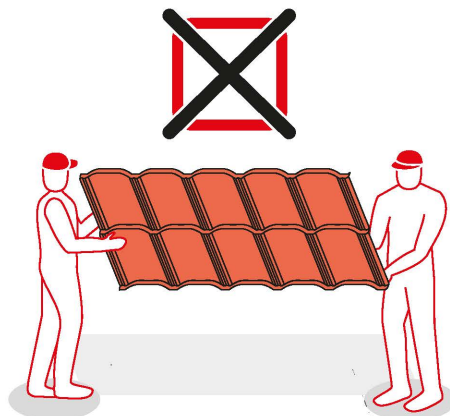
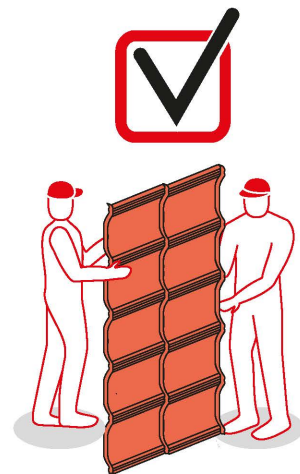
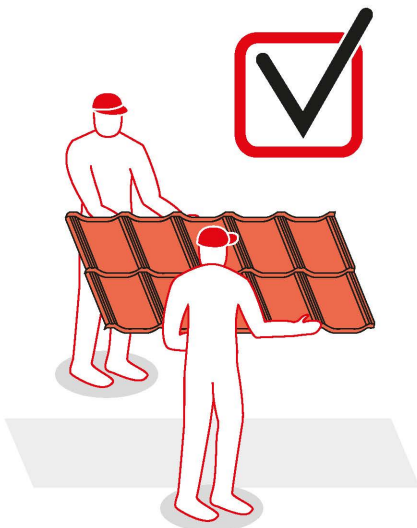
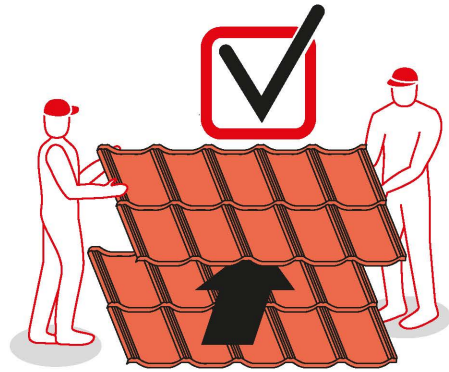
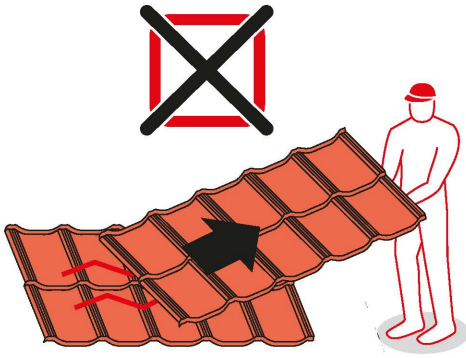

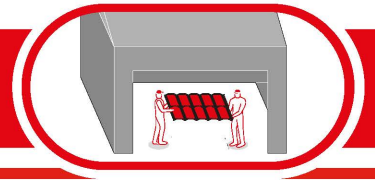

3

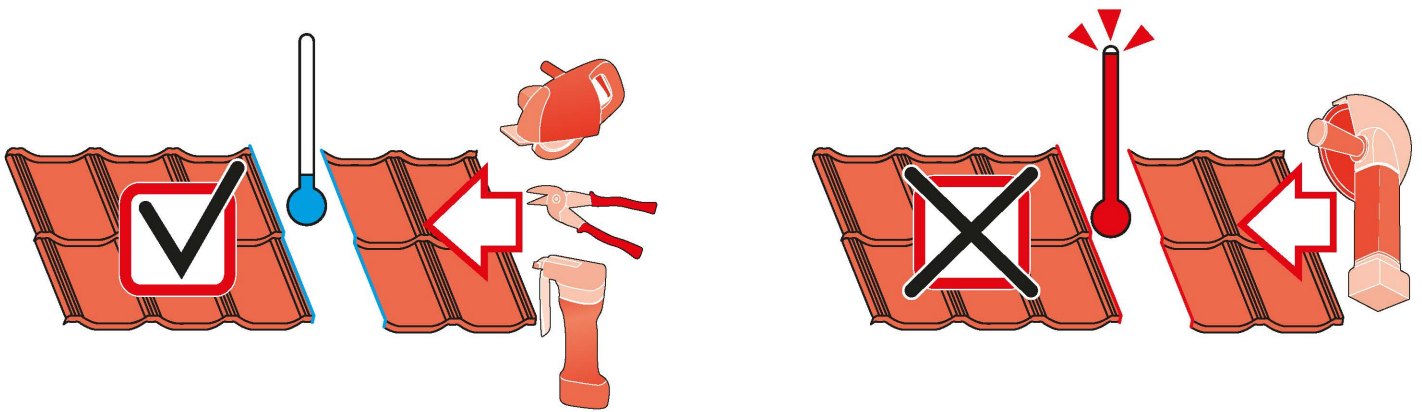

4

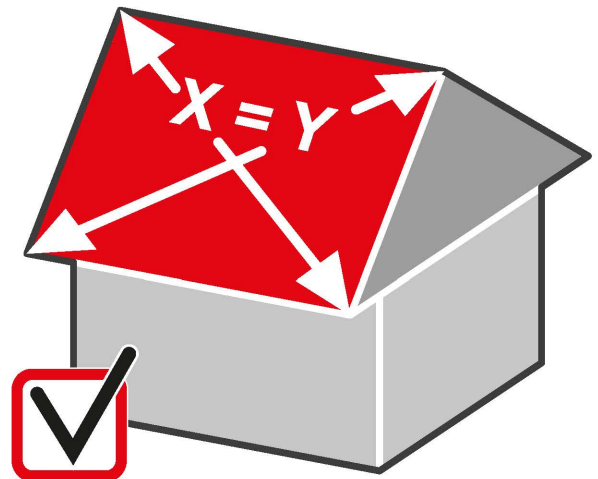
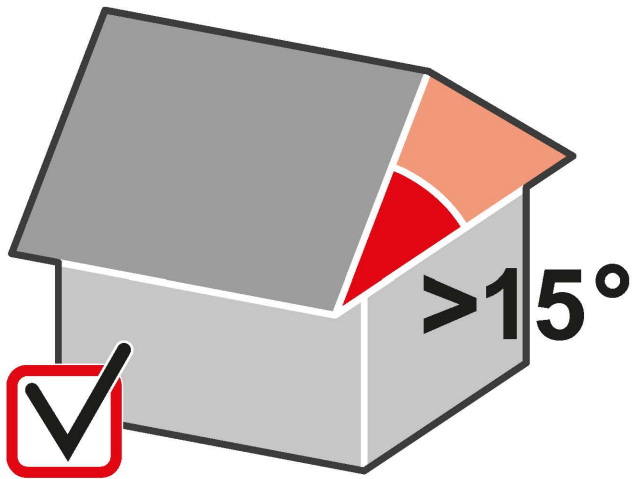

5

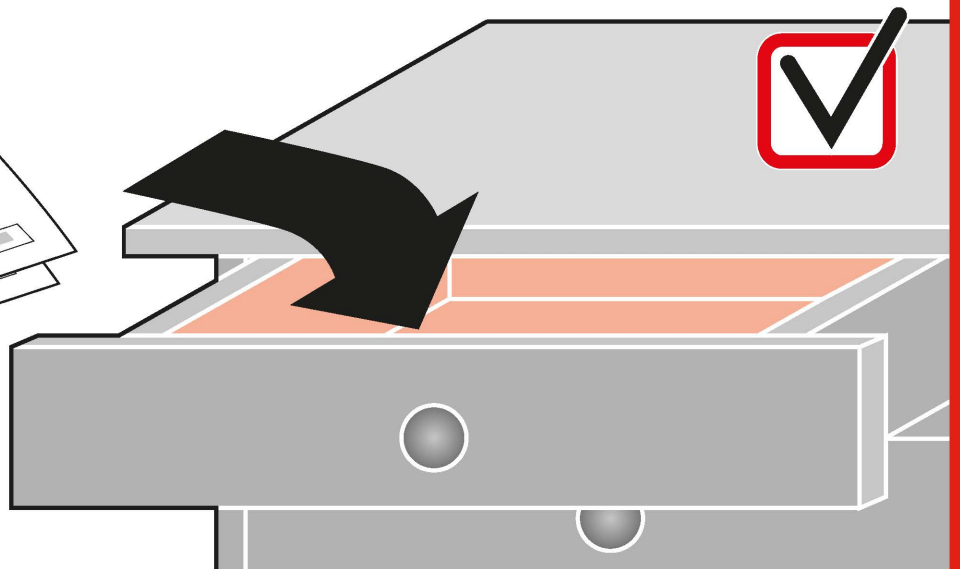
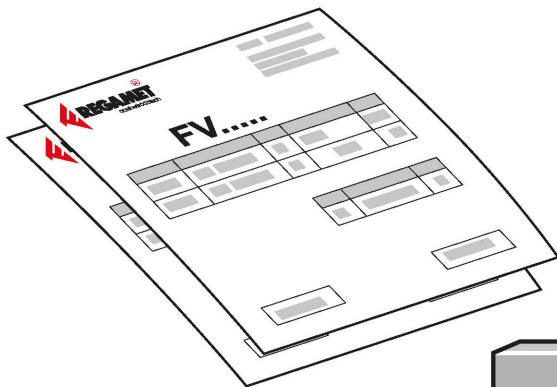

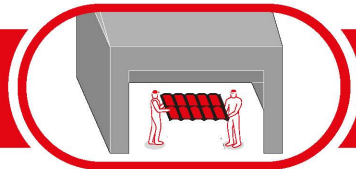

6

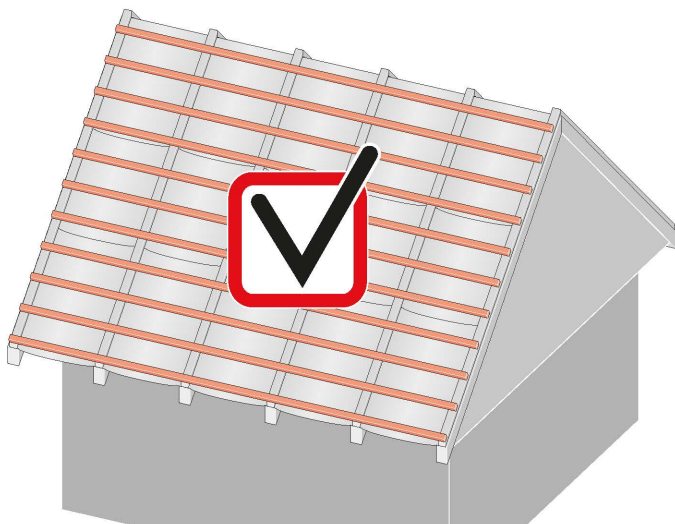
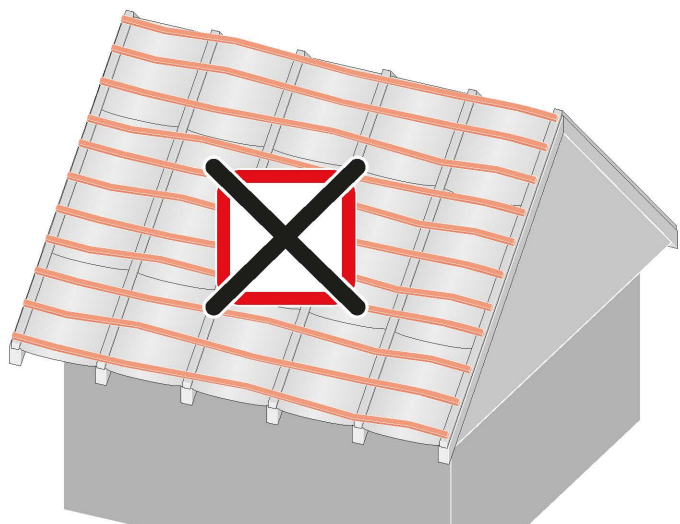
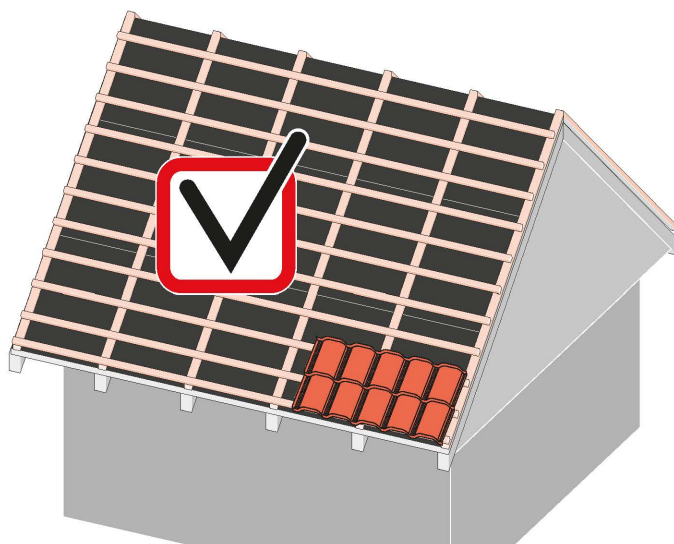
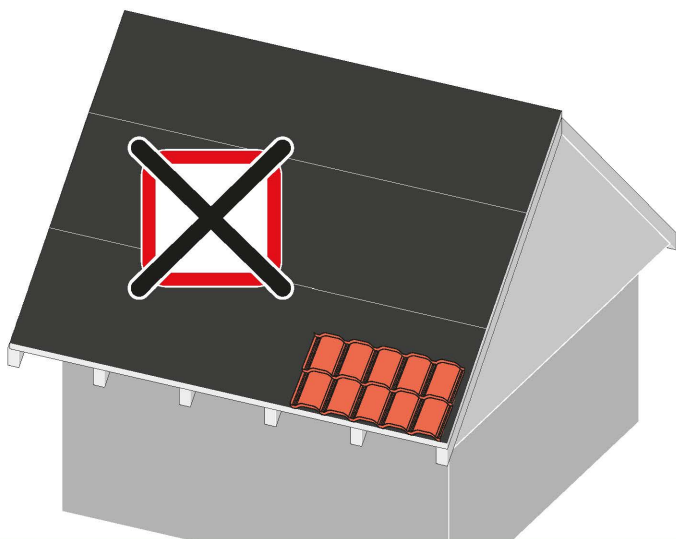
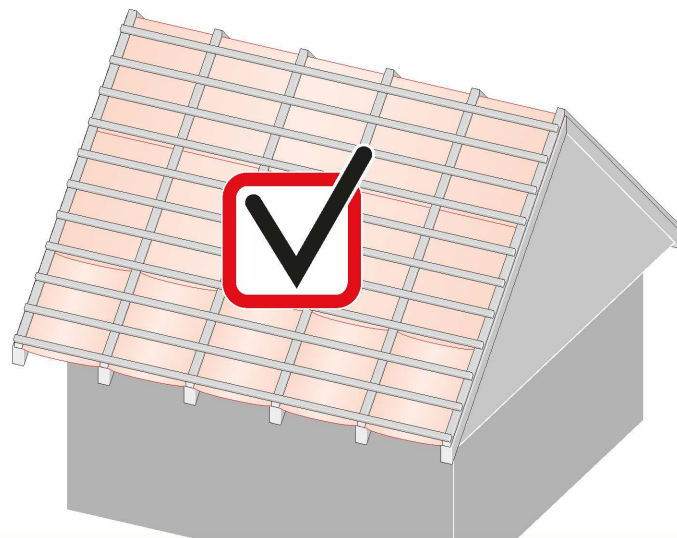
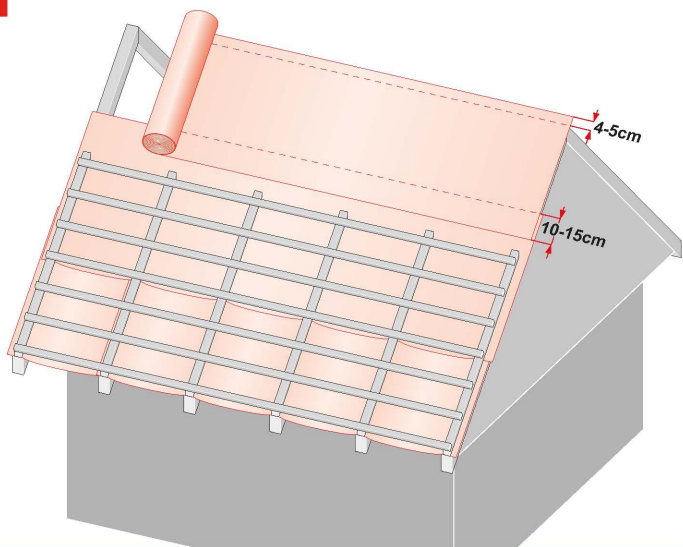

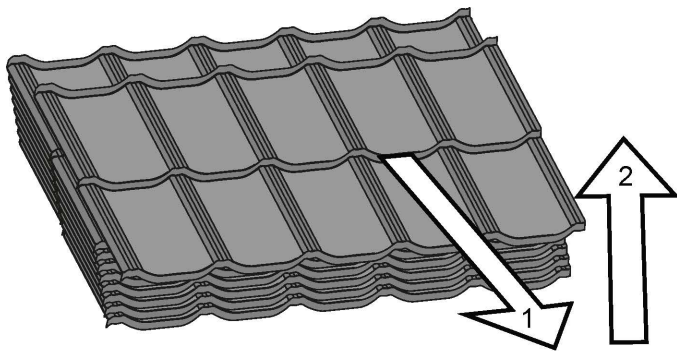
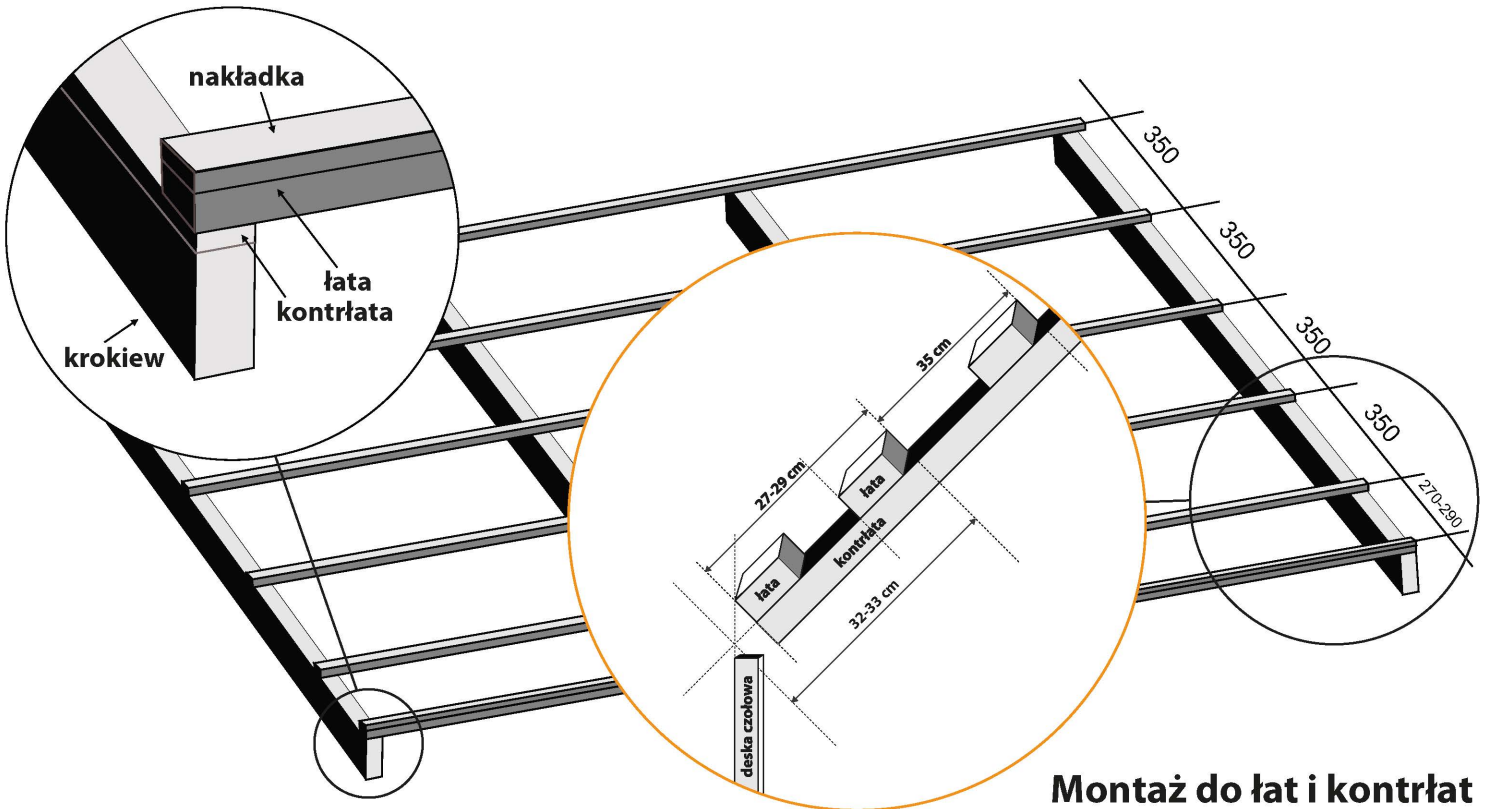
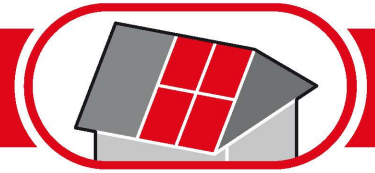

Pobieranie arkuszy z palety

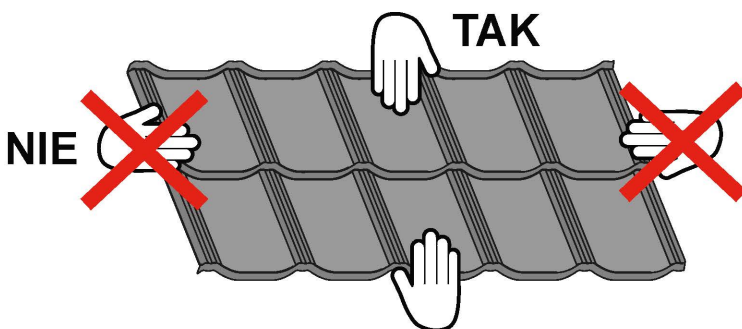

Przenoszenie arkuszy

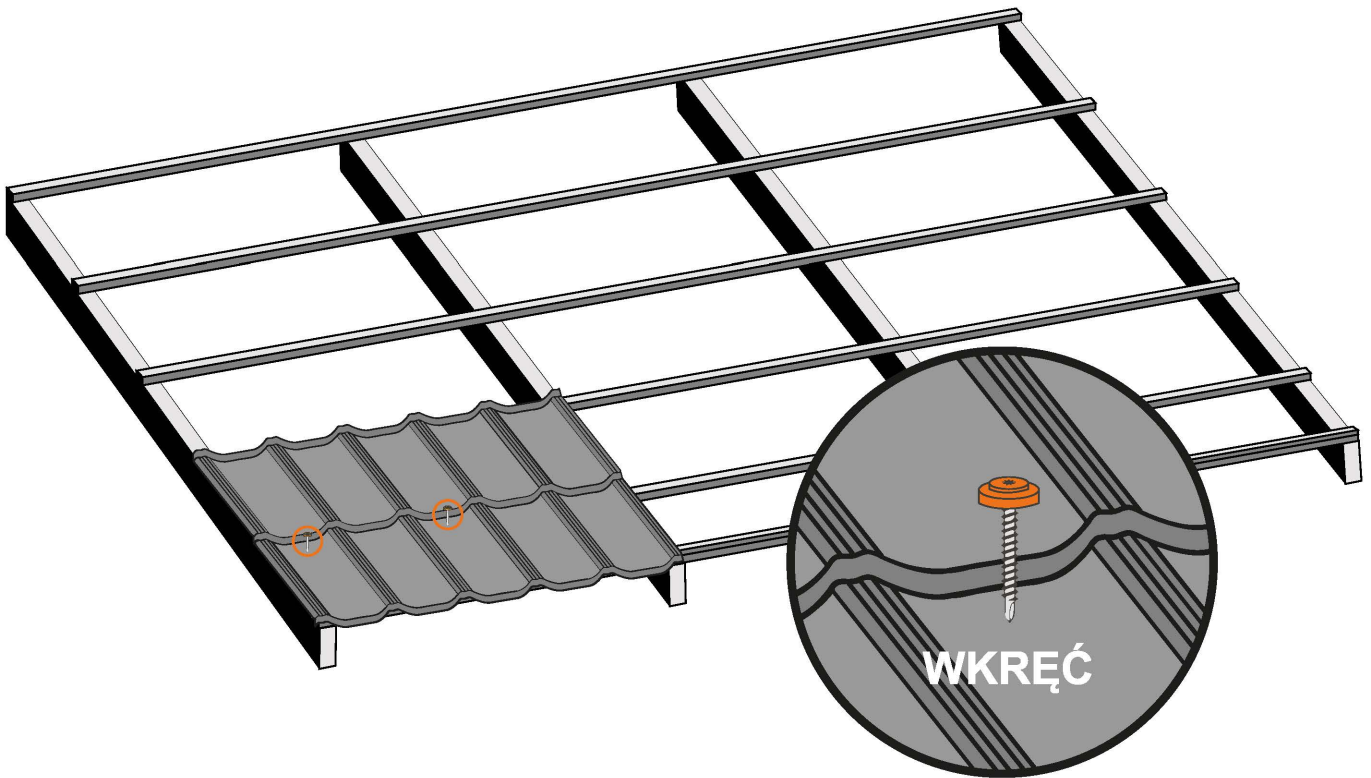
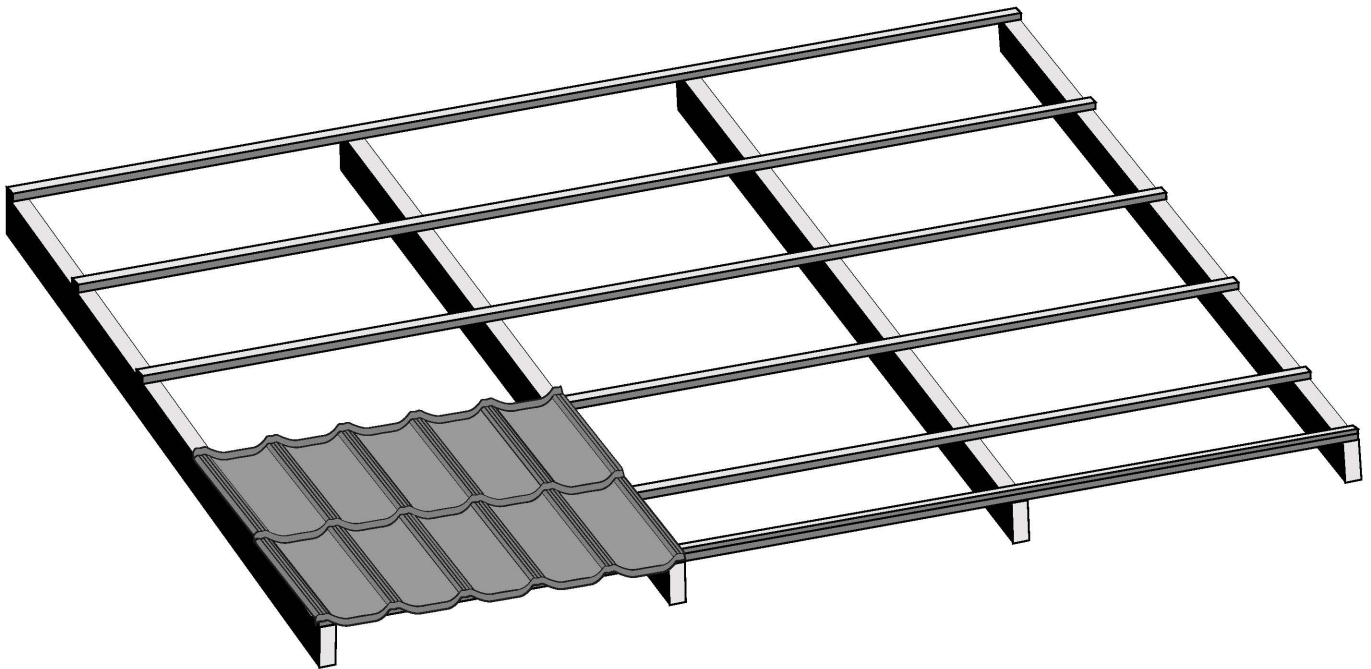
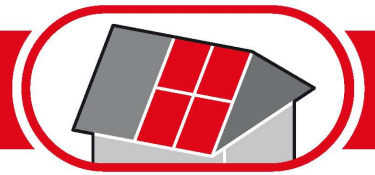

WKREĆ DO ŁATY (DŁUGI)



WKREĆ DO ZSZYWANIA (KRÓTKI)



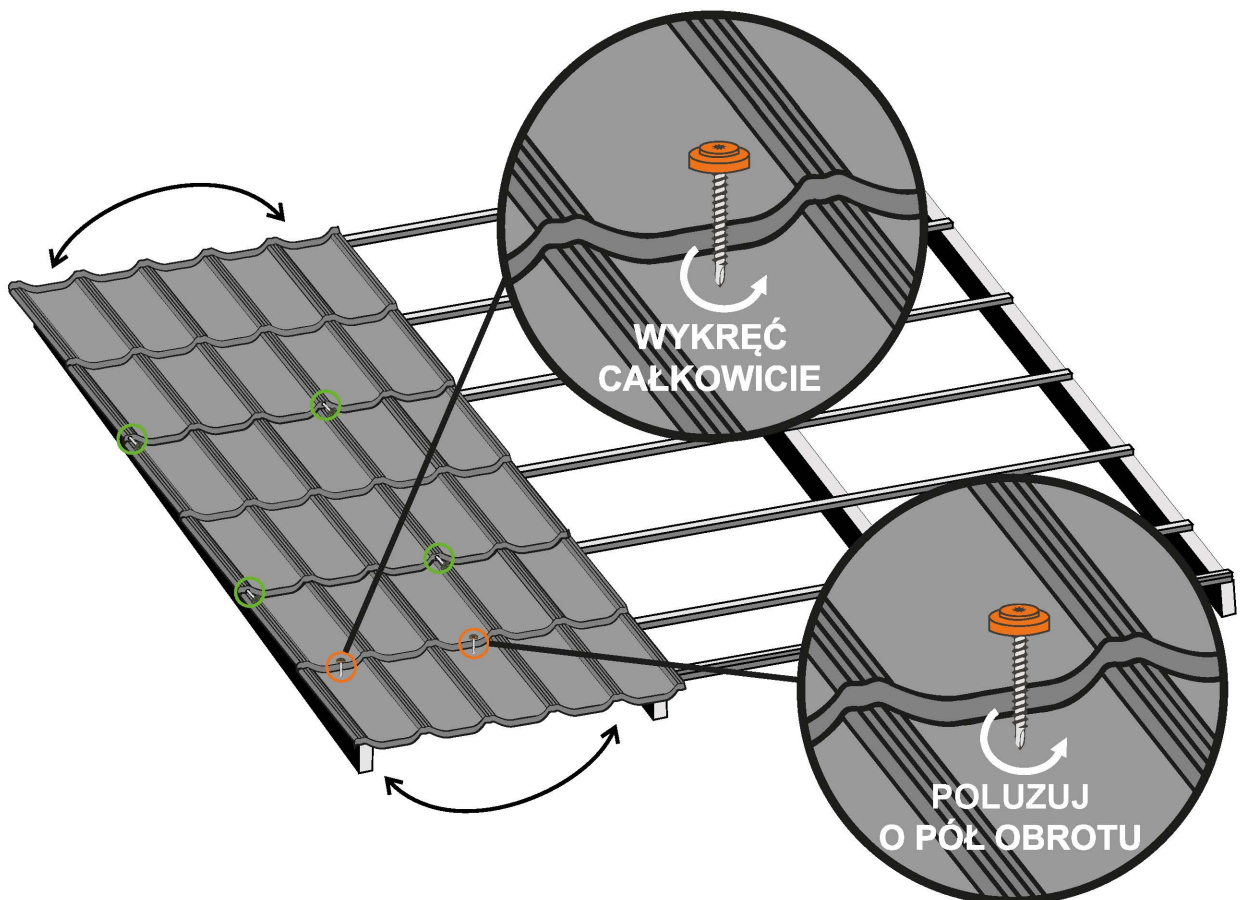
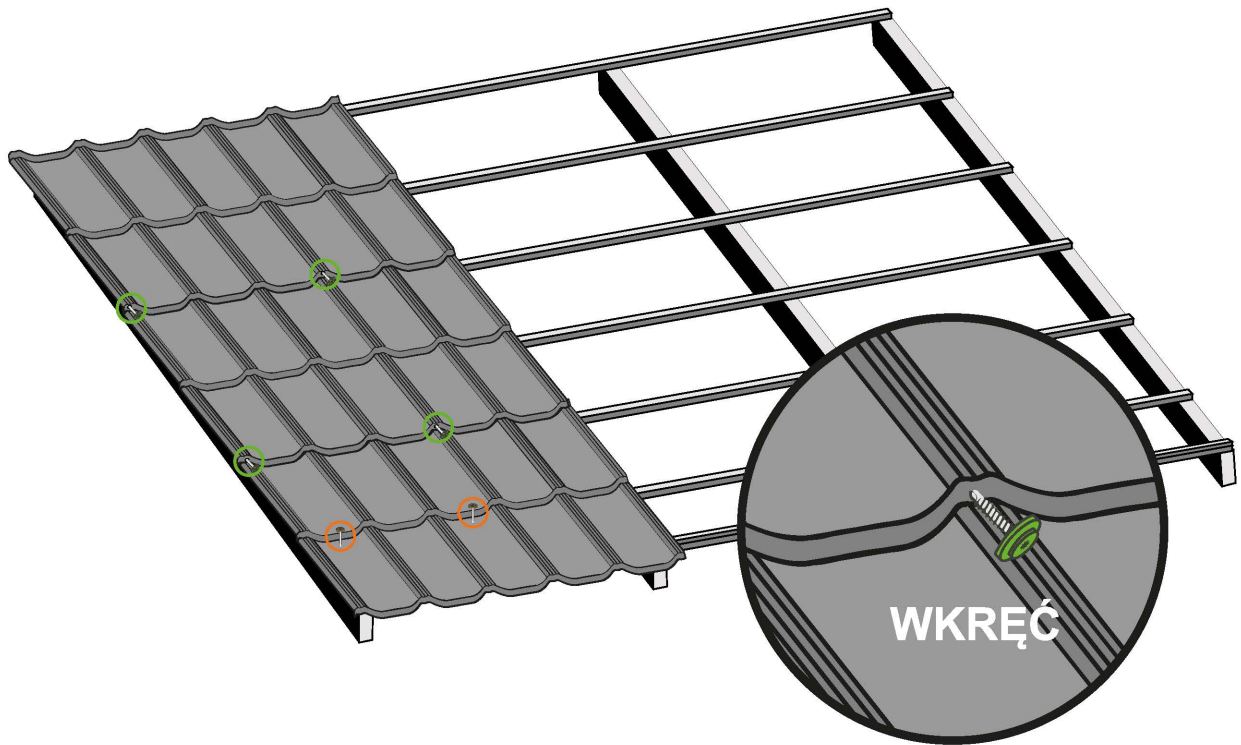
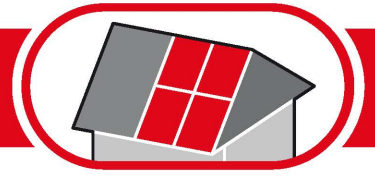

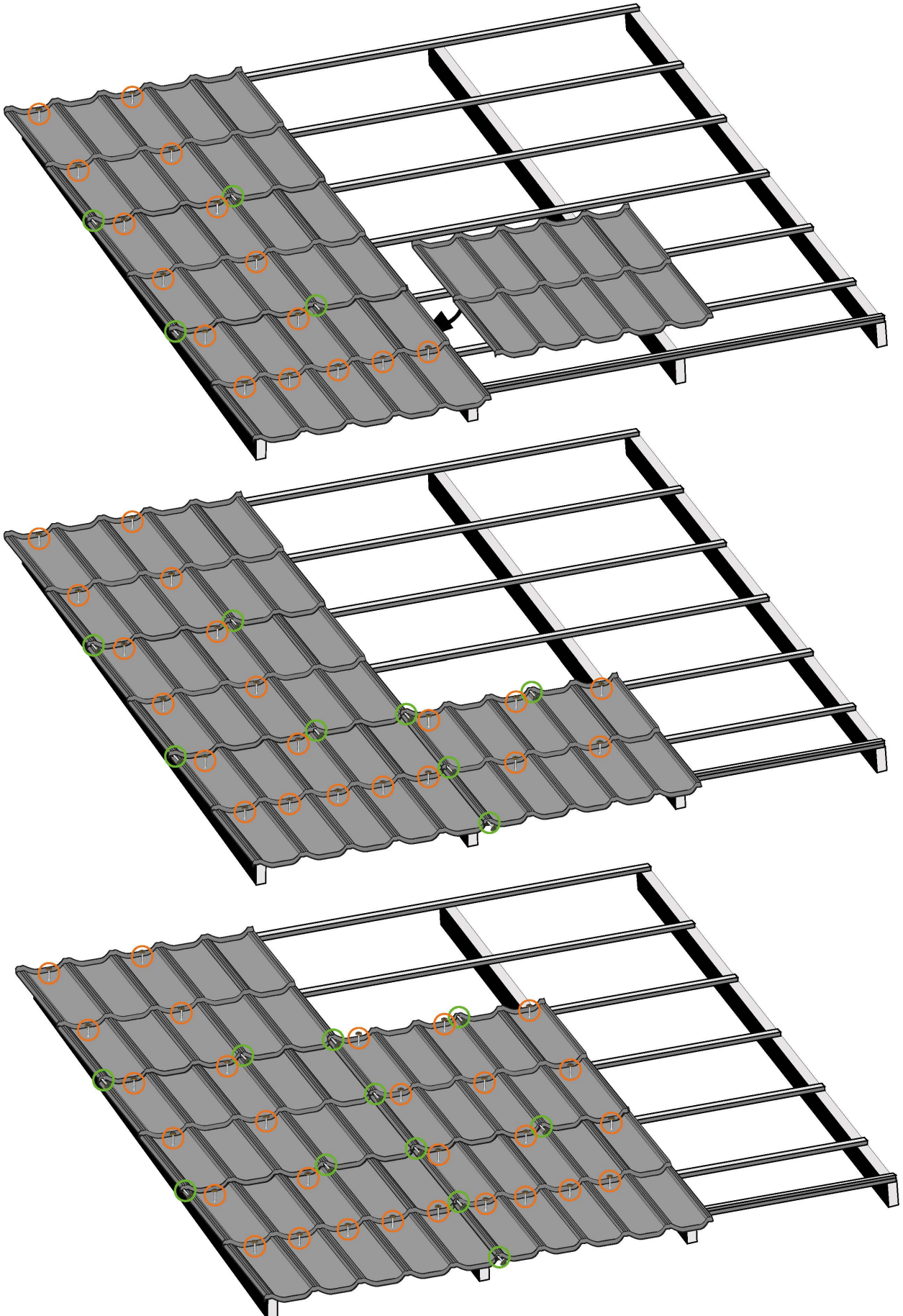
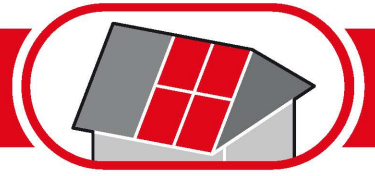

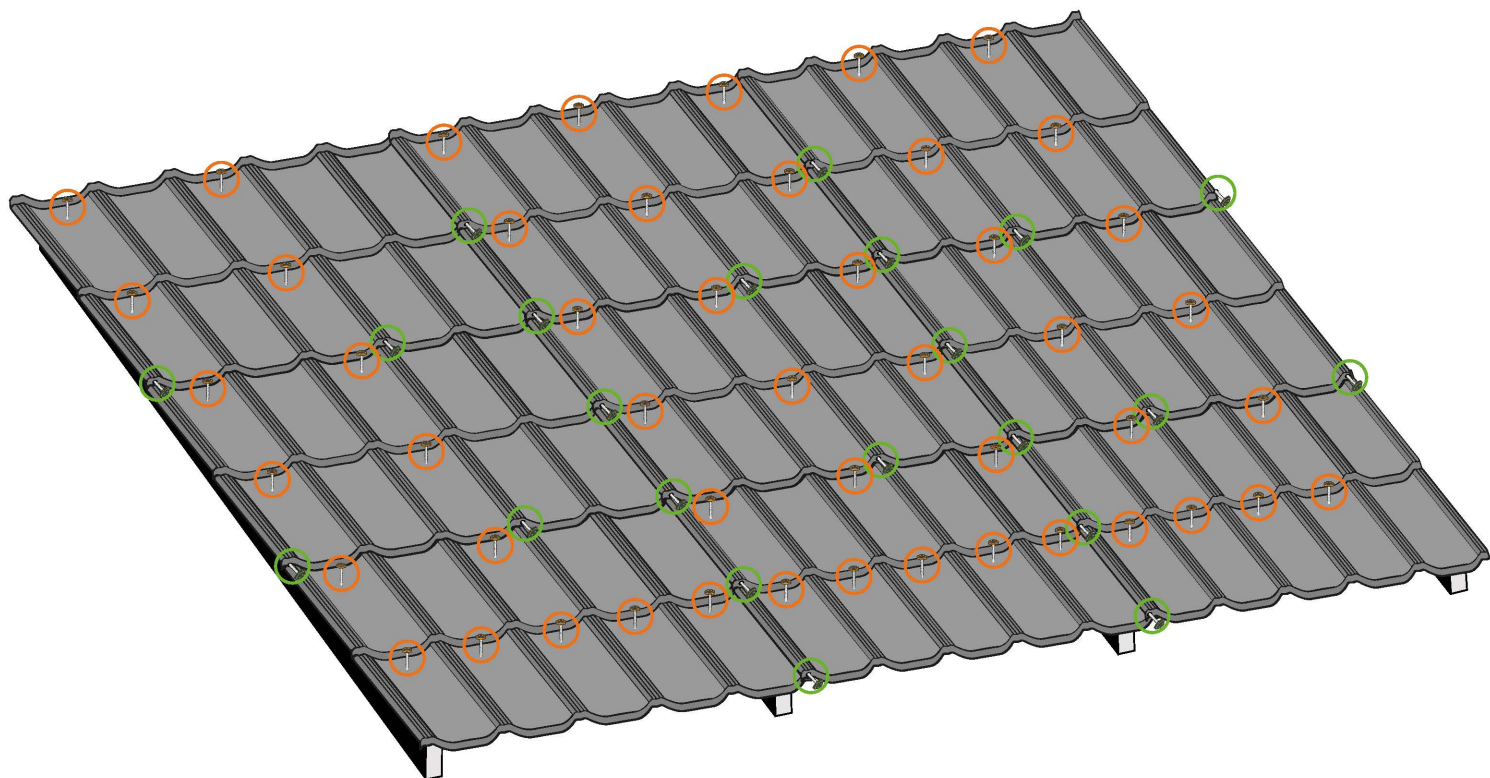
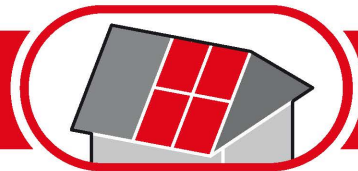

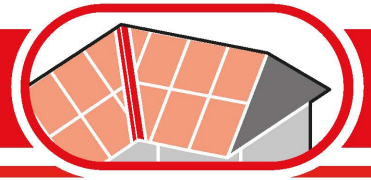

7

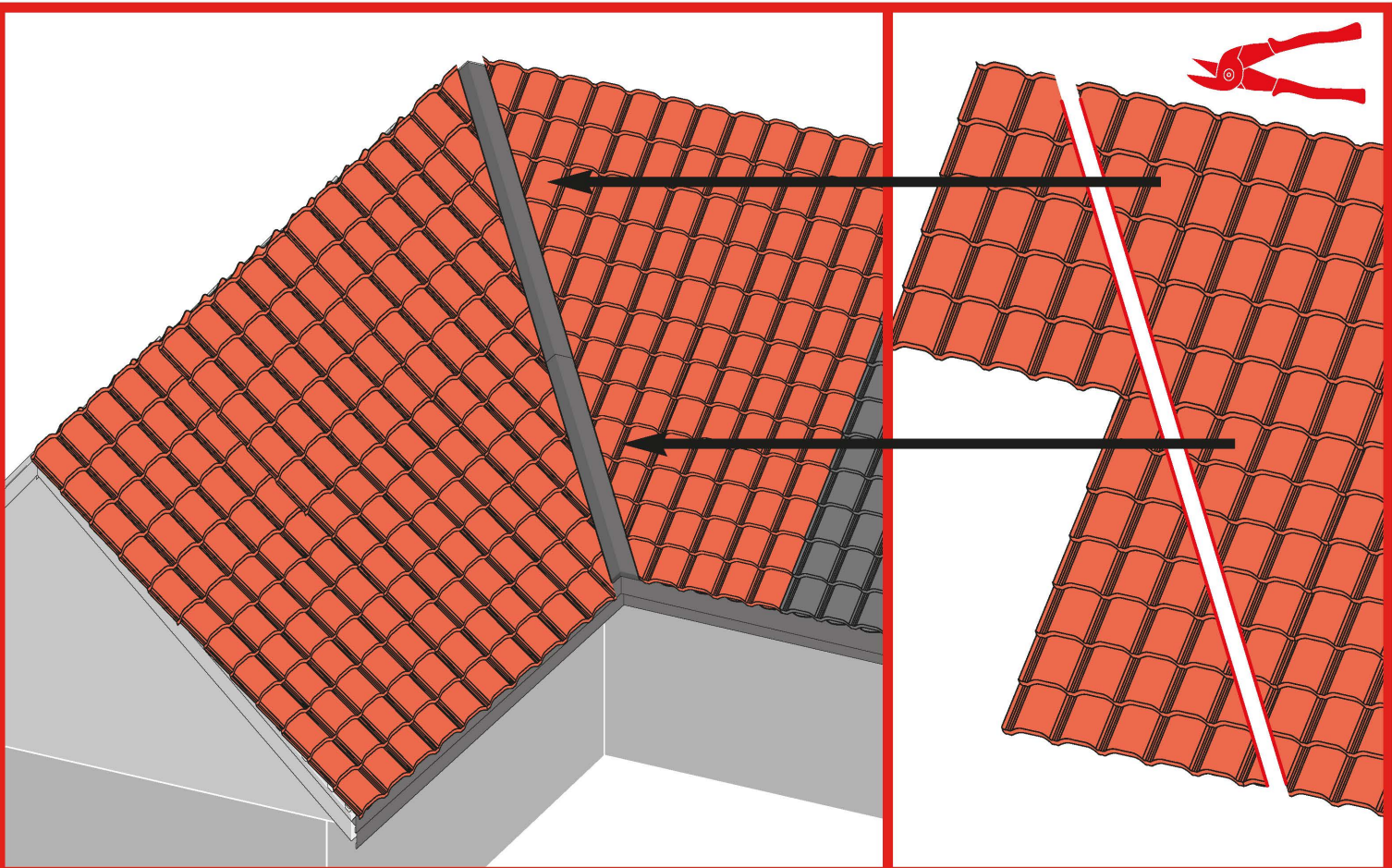
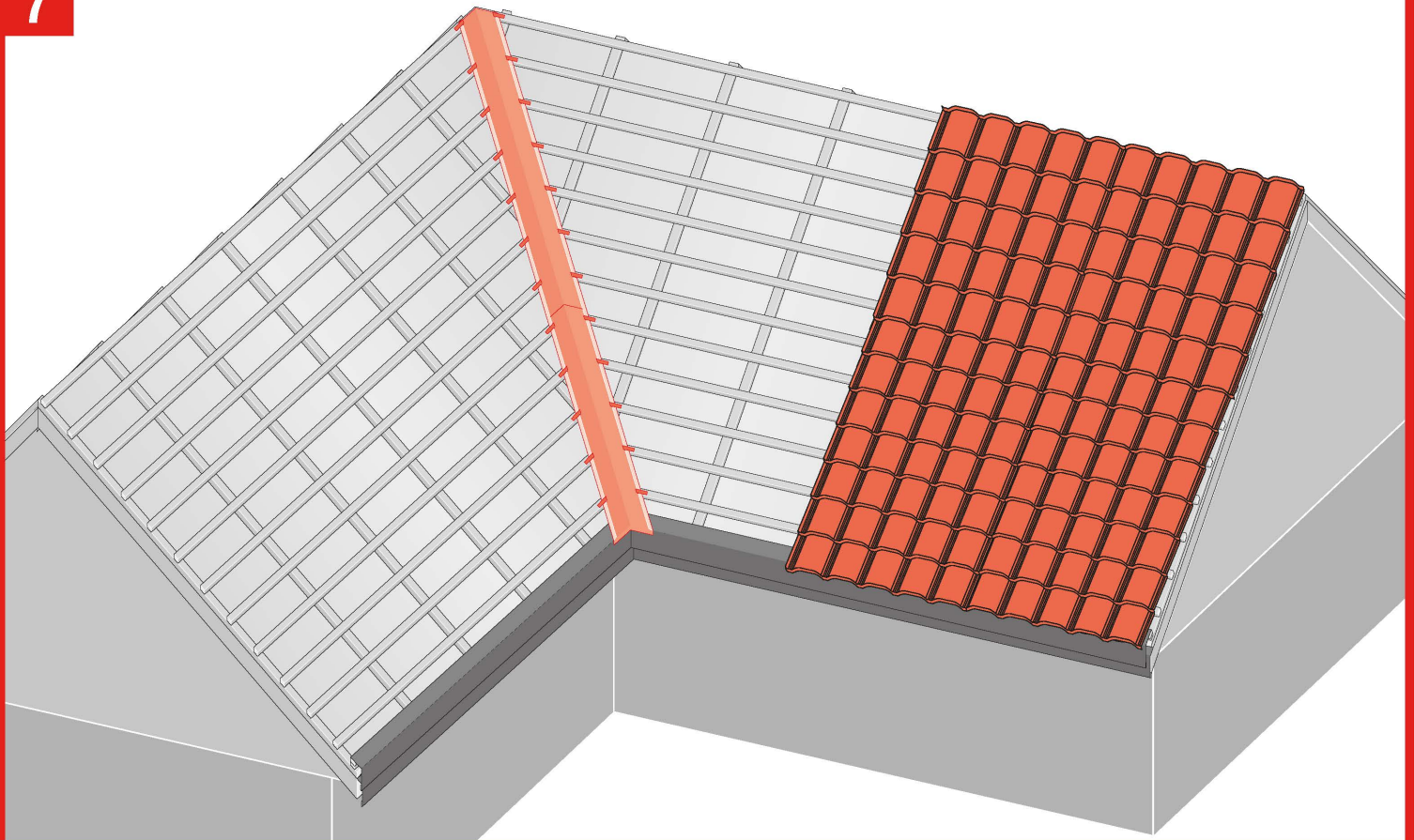

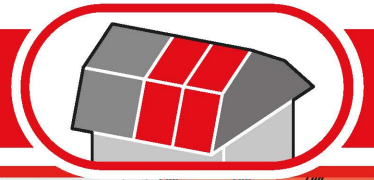

8

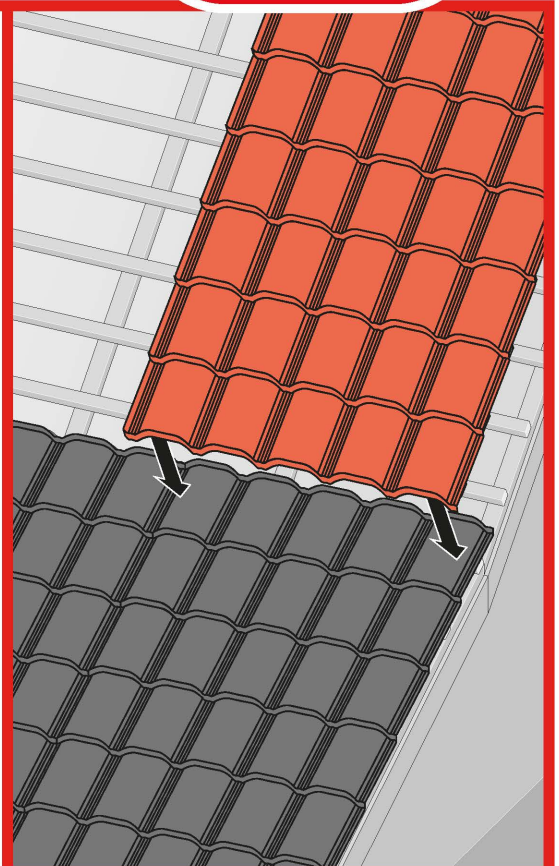
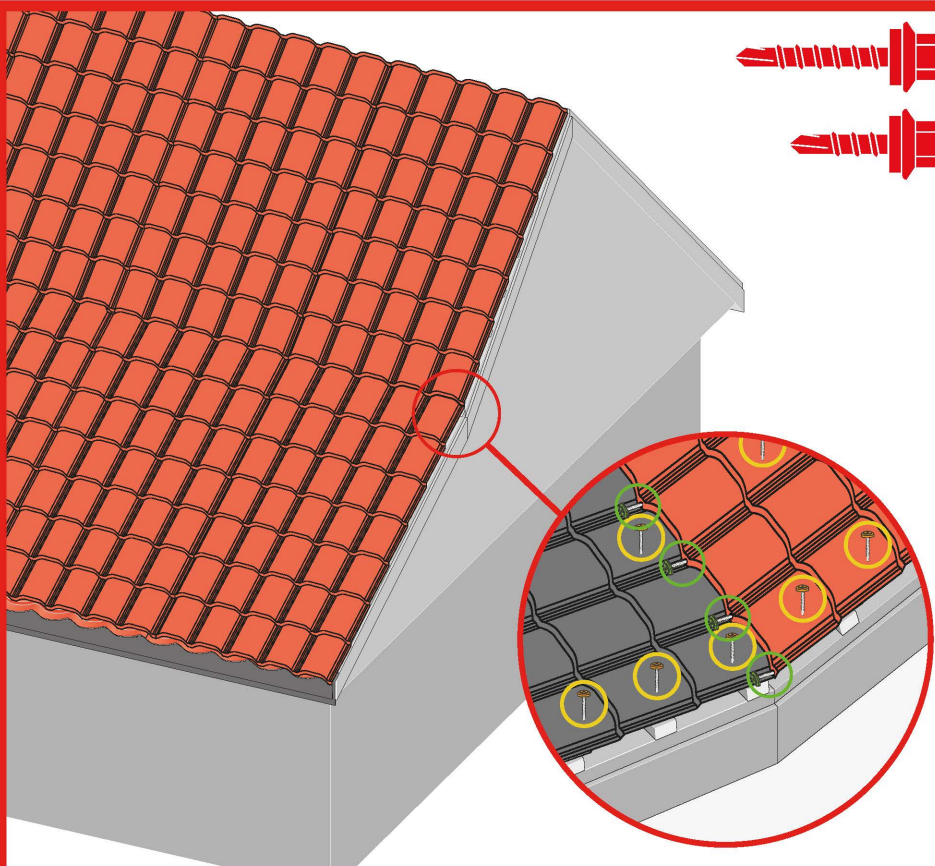
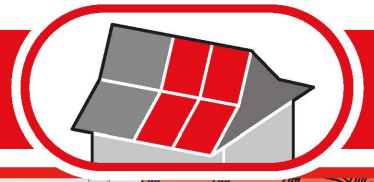
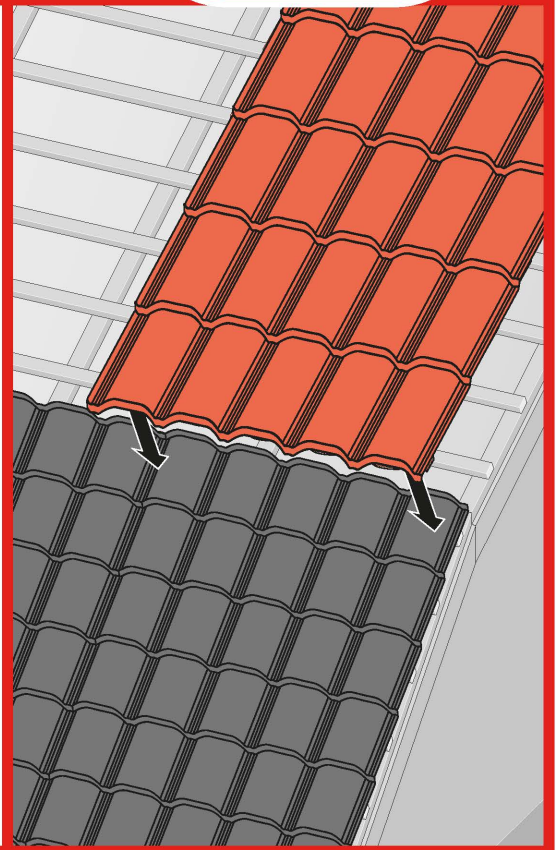
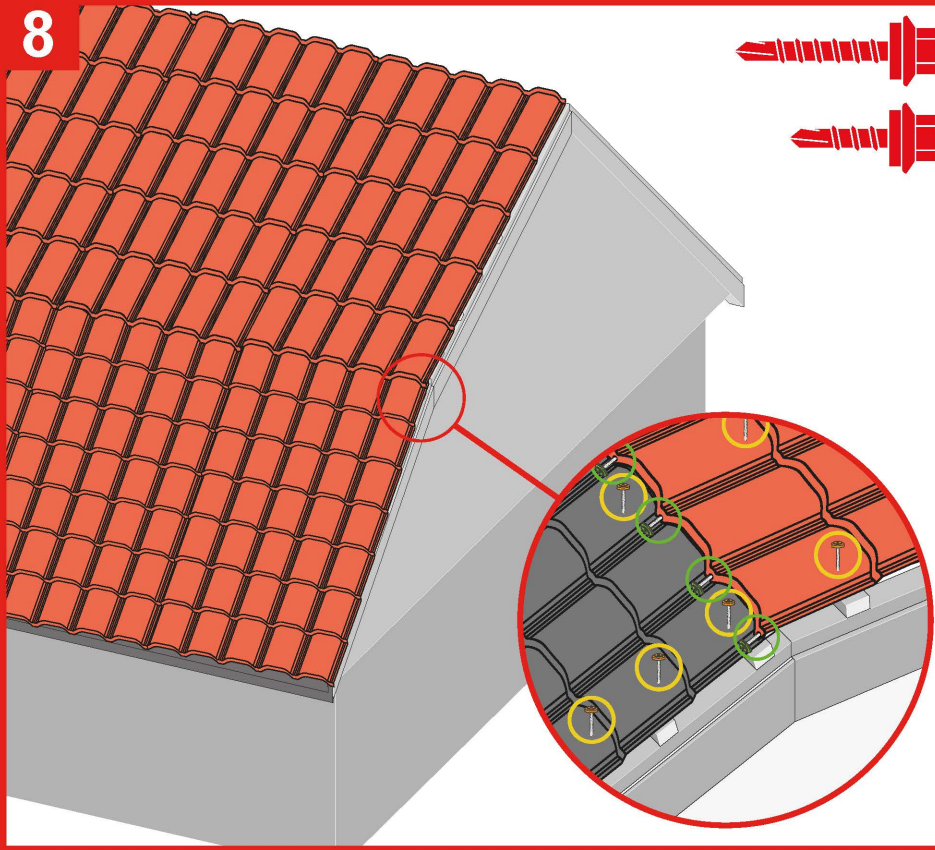

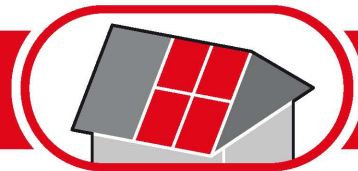

Niniejsza instrukcja jest materiałem poglądowym i nie zwalnia wykonawców z obowiązku przestrzegania zasad sztuki dekarzkiej oraz stosowania się do norm budowlanych. Sposoby montażu przedstawione w tej instrukcji mają charakter wskazówek ogólnych, dlatego różnice w doborze odpowiedniej metody, mogą wynikać z różnego rodzaju dachu i metod krycia w regionie zwłaszcza w przypadku blach nie posiadających rowka kapilarnego, które to mogą wymagać podczas montowania na dachu, dodatkowego uszczelnienia np. taśmą butylową, celem zapobieżenia kapilarnemu podciąganiu wody. Montaż blach dachowych wymaga fachowej wiedzy, praktyki i specjalizacji, dlatego doświadczeni wykonawcy posiadają indywidualne rozwiązania, które firma REGAMET aprobuje.

W celu zapobiegania "jodełkowaniu" zaleca się krycie naprzemienne tj. drugi rząd nakładać na pierwszy, natomiast trzeci podkładać pod drugi.