

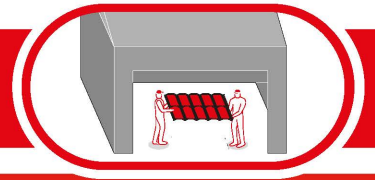

# EKSKLUZYWNE POKRYCIA DACHOWE

**Skrócona  
instrukcja  
montażu  
blachodachówki  
modułowej  
Elektra, Liwia,  
Mona, Petra  
z kryciem w pasach  
od prawej do lewej**  
[www.regamet.pl](http://www.regamet.pl)





## ELEKTRA duo

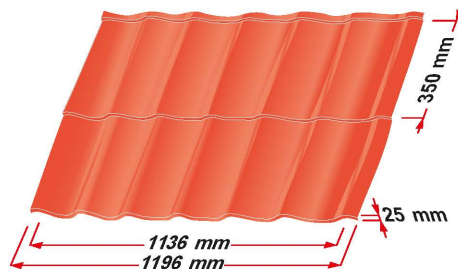

## LIWIA duo

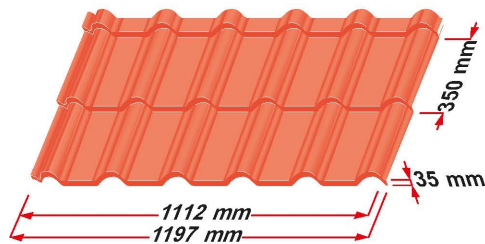

## MONA duo

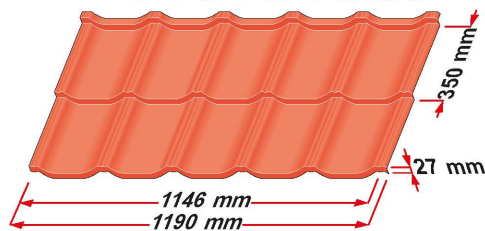

## PETRA duo

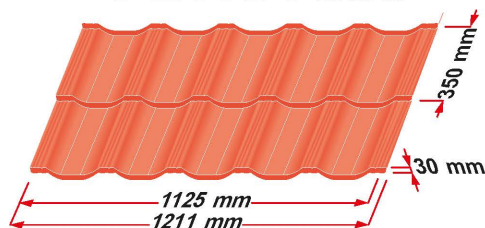

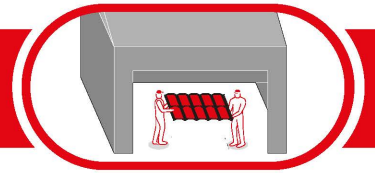

1

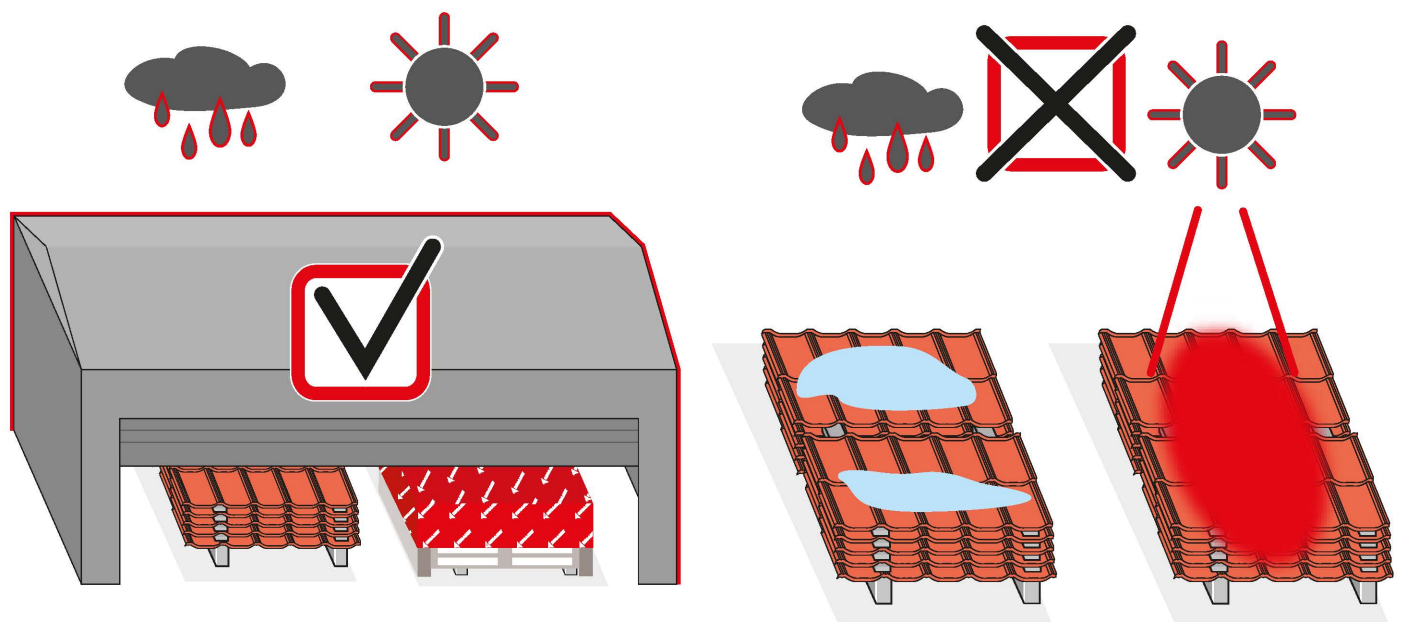
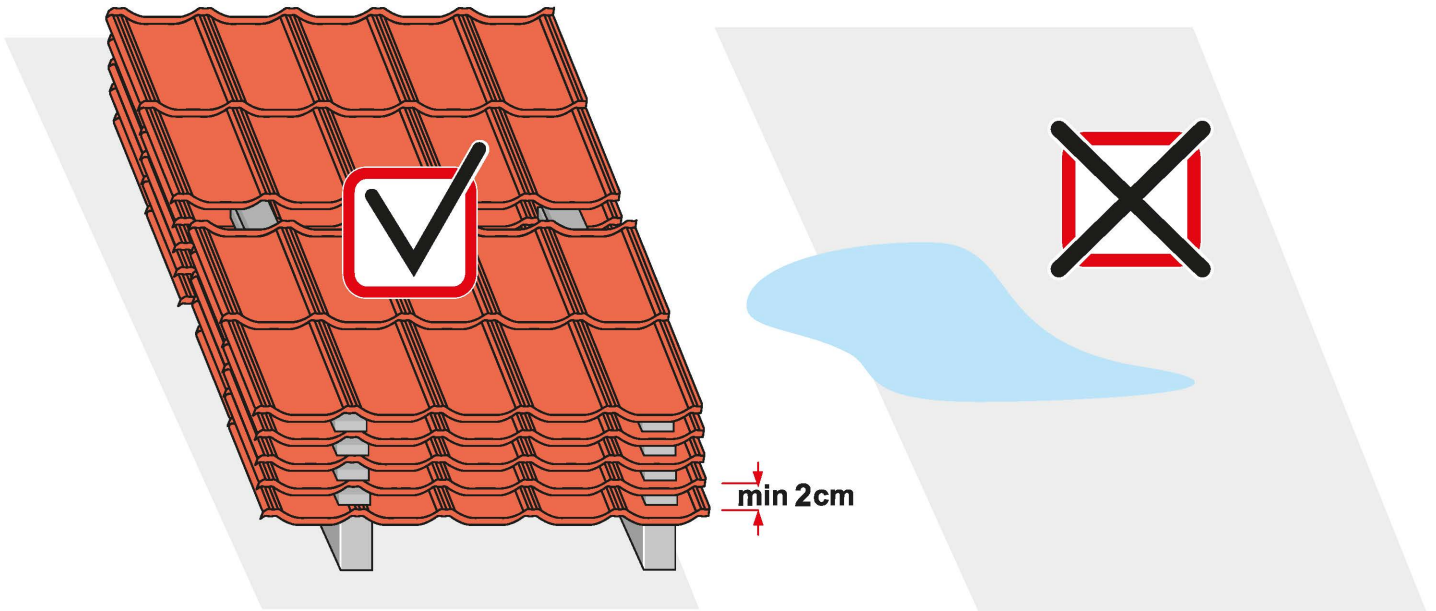

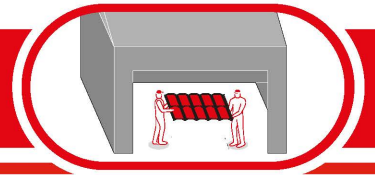

2

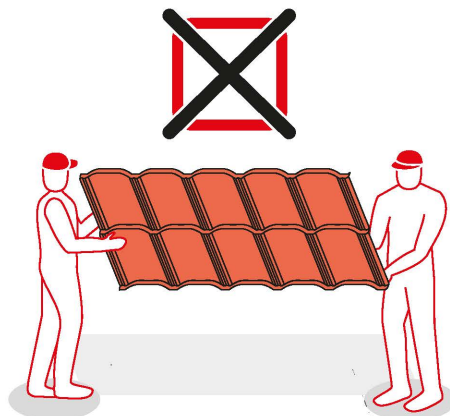
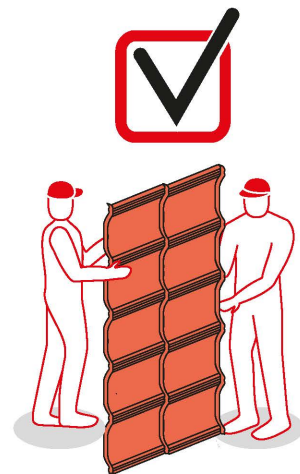
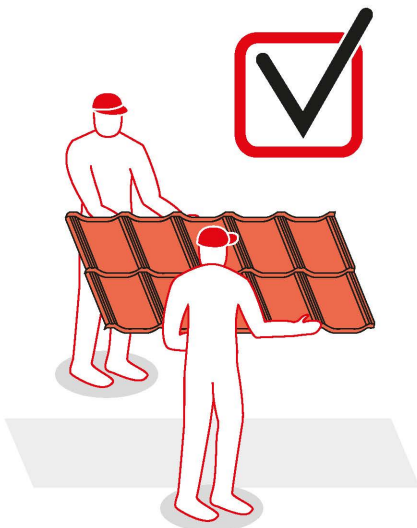
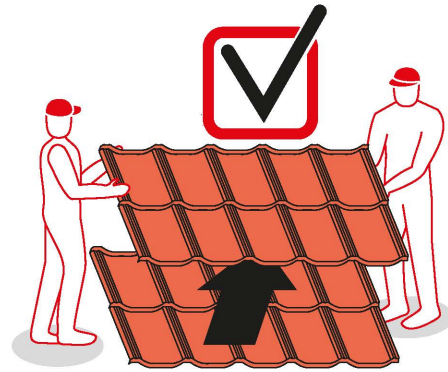
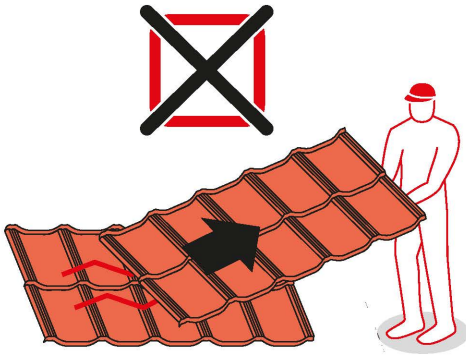

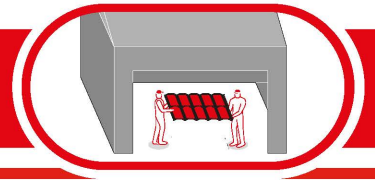

3

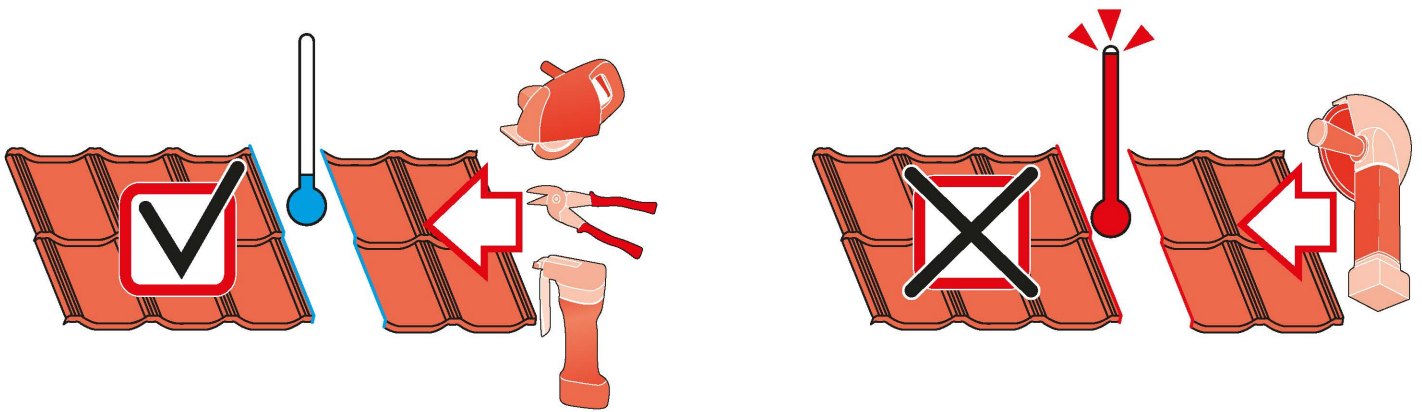

4

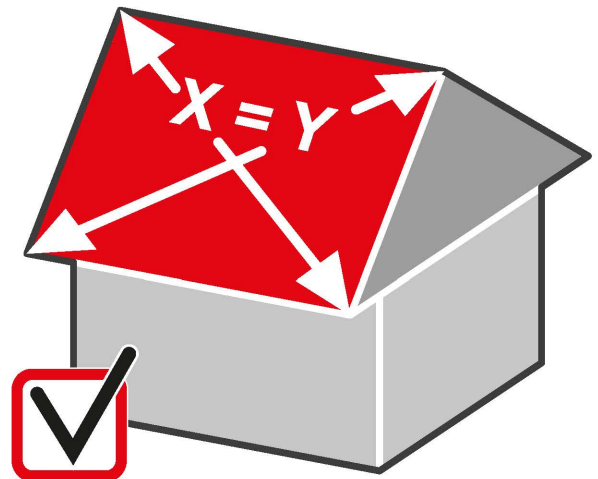
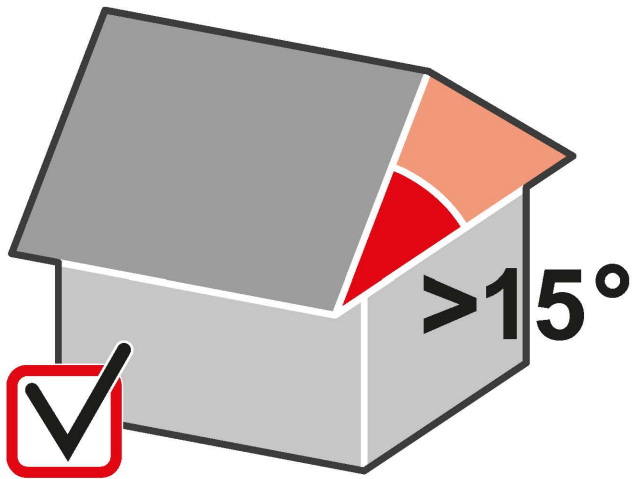

5

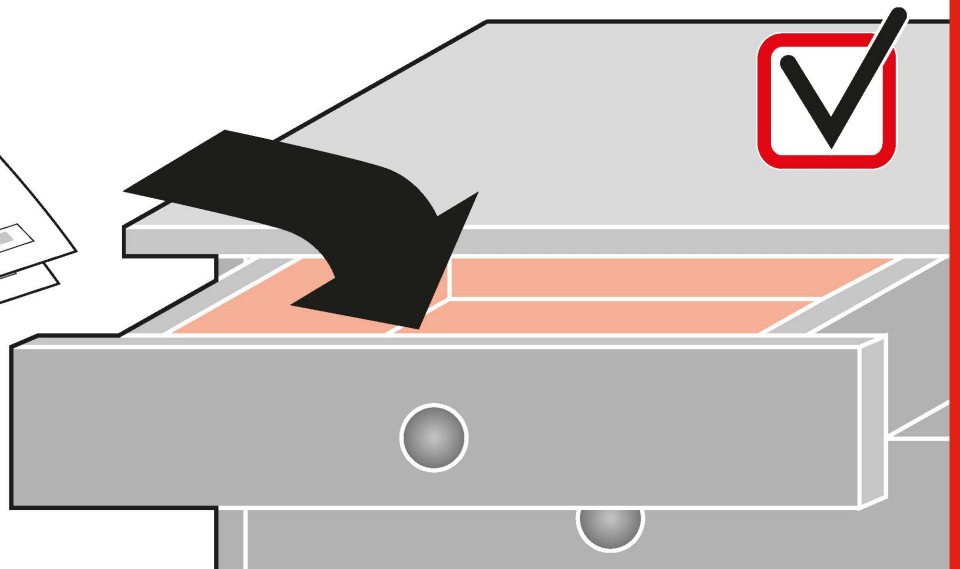
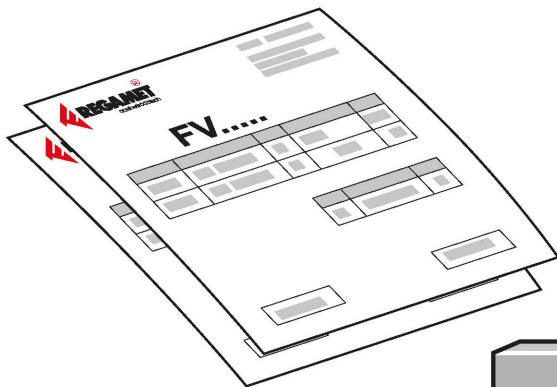

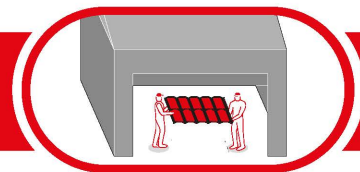

6

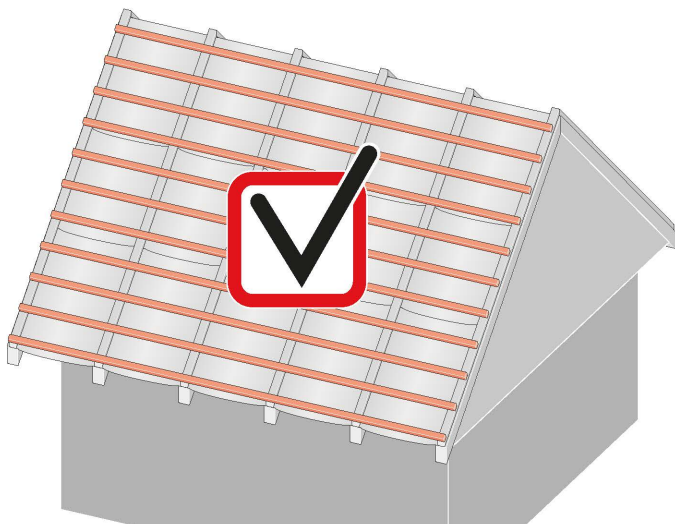
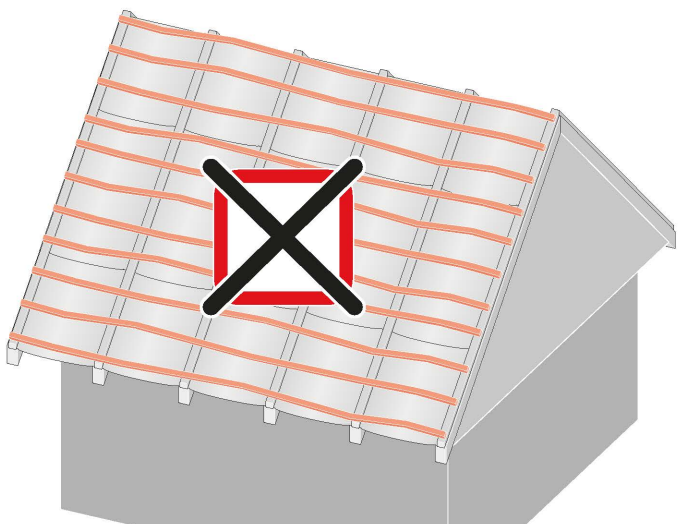
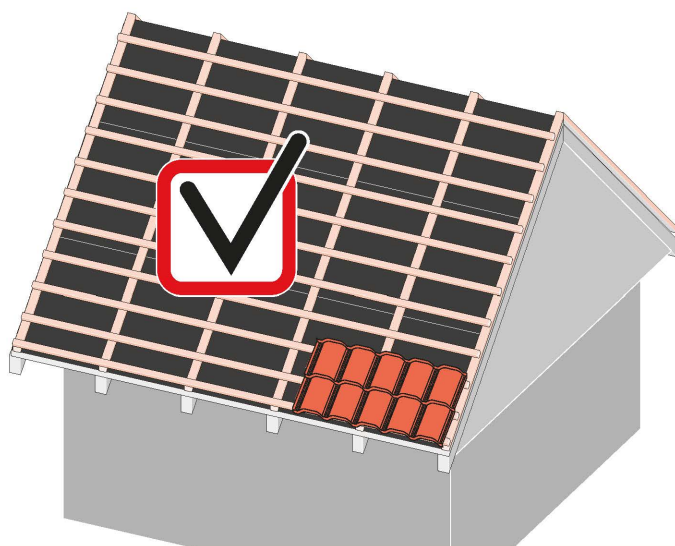
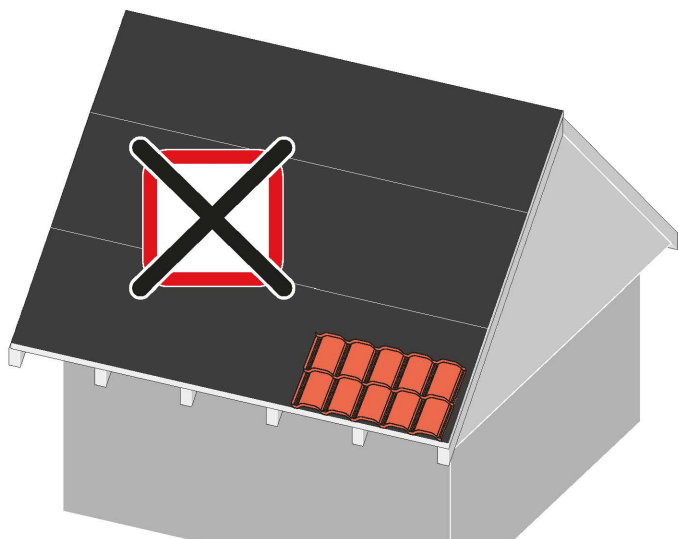
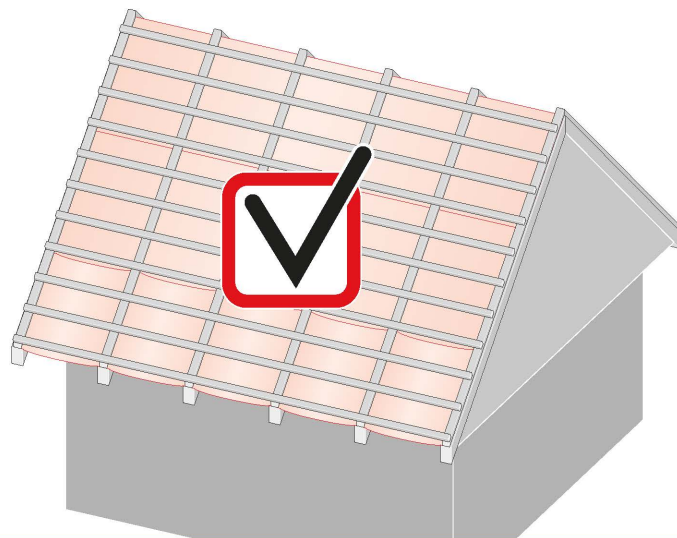
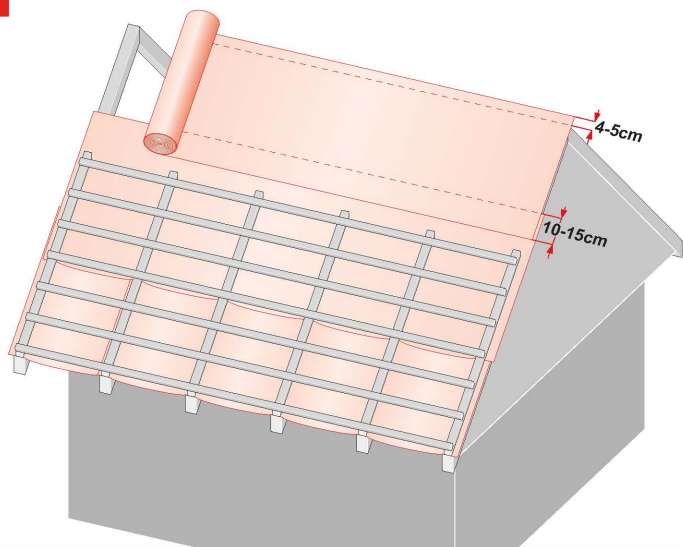

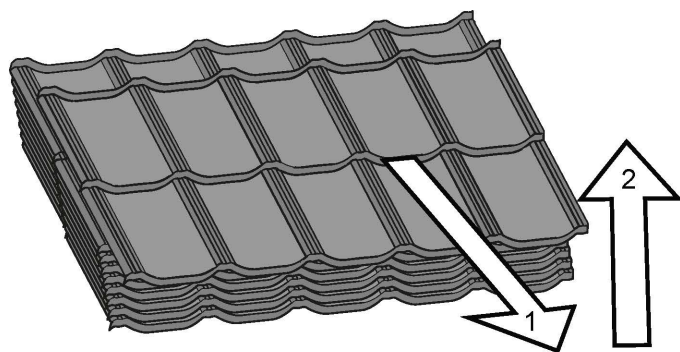
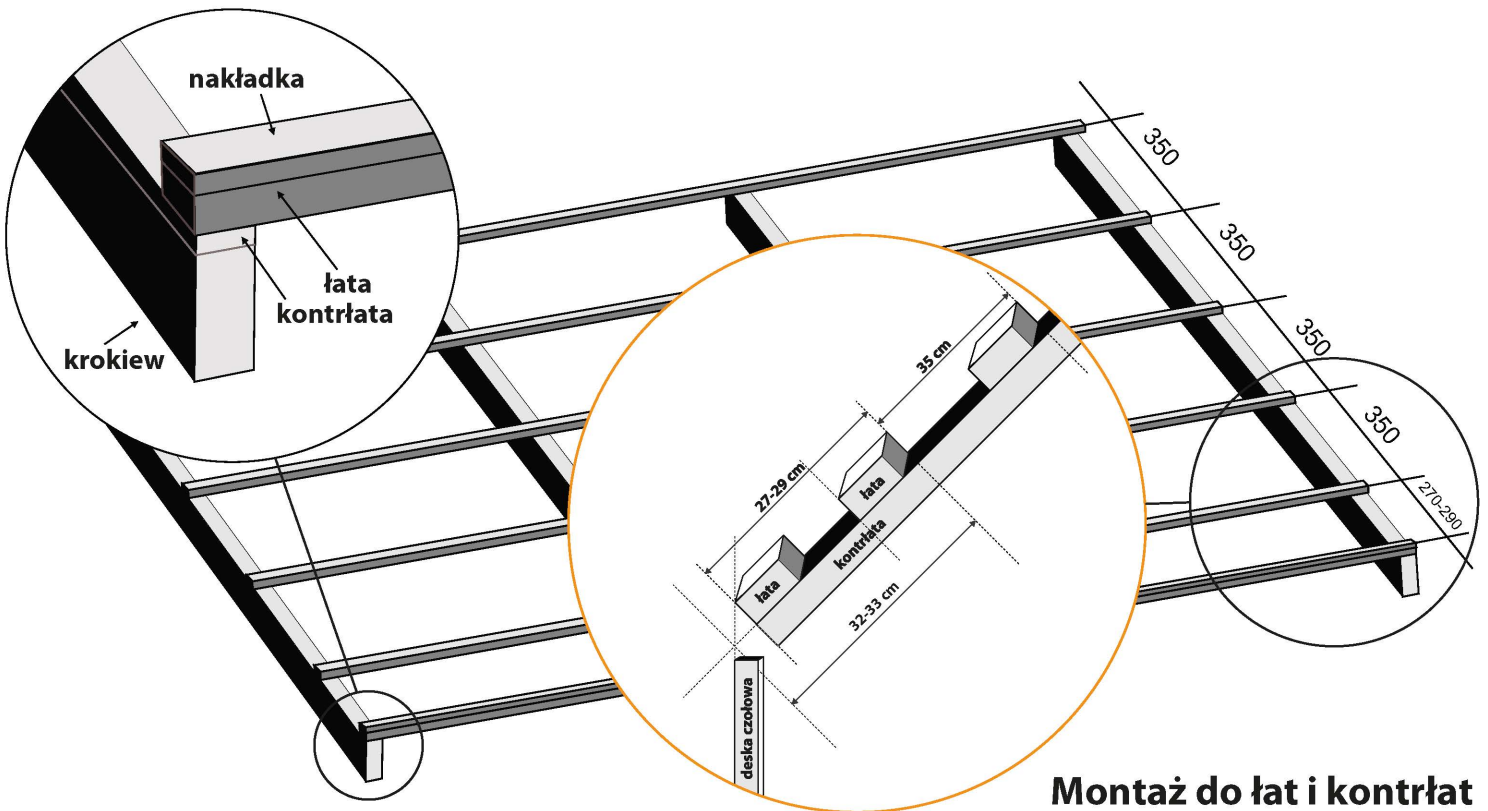
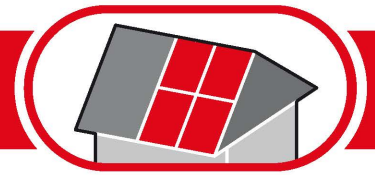

Pobieranie arkuszy z palety

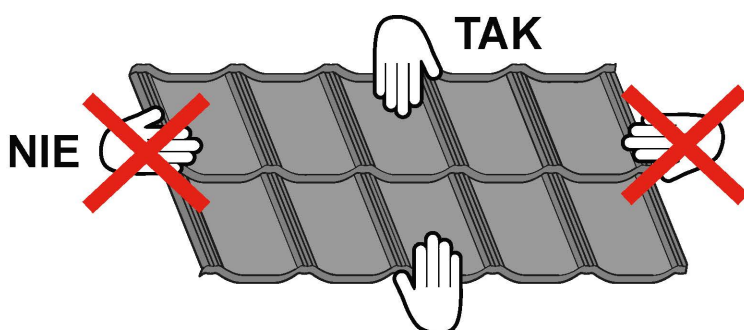

Przenoszenie arkuszy

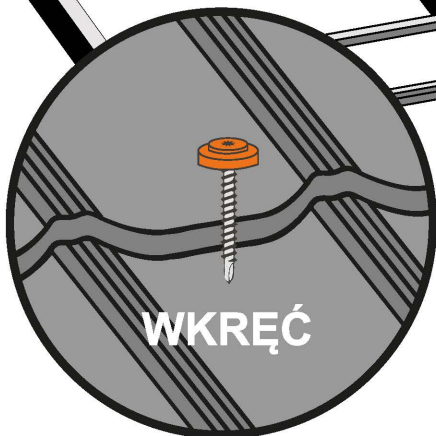
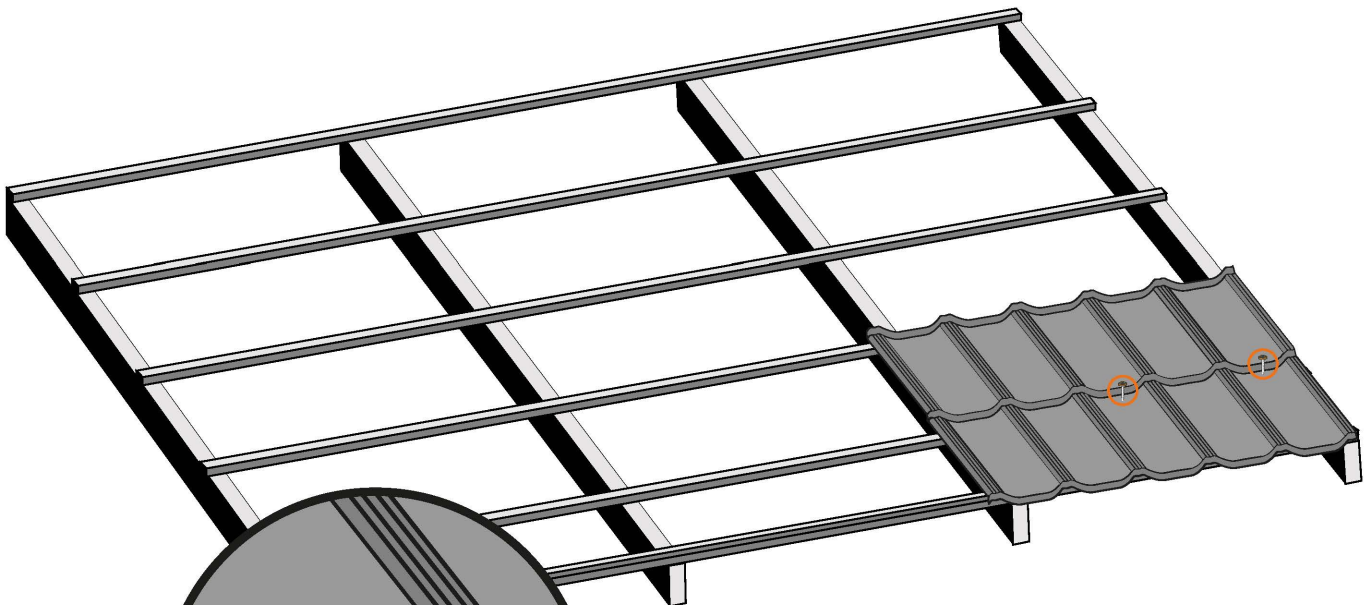
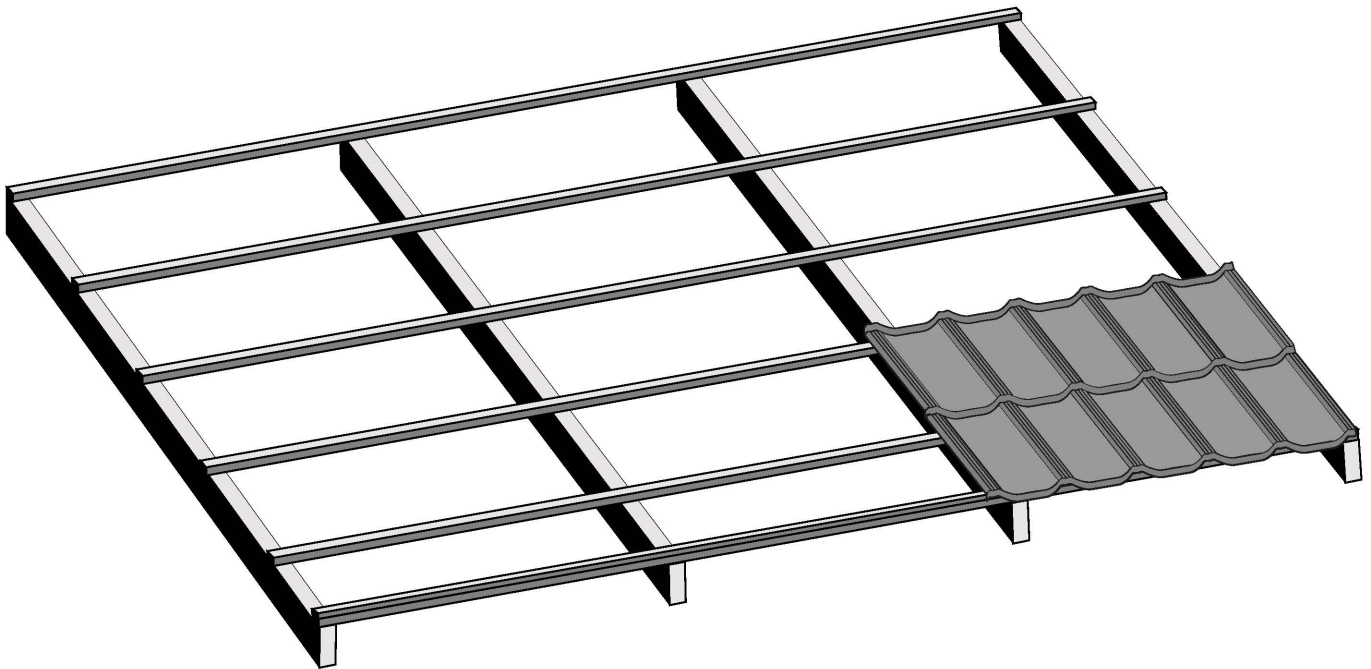
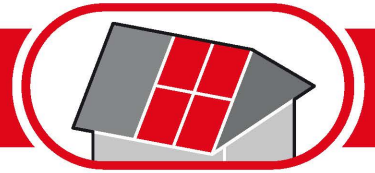

WKREĆ

WKREĆ DO ŁATY (DŁUGI)



WKREĆ DO ZSZYWANIA (KRÓTKI)





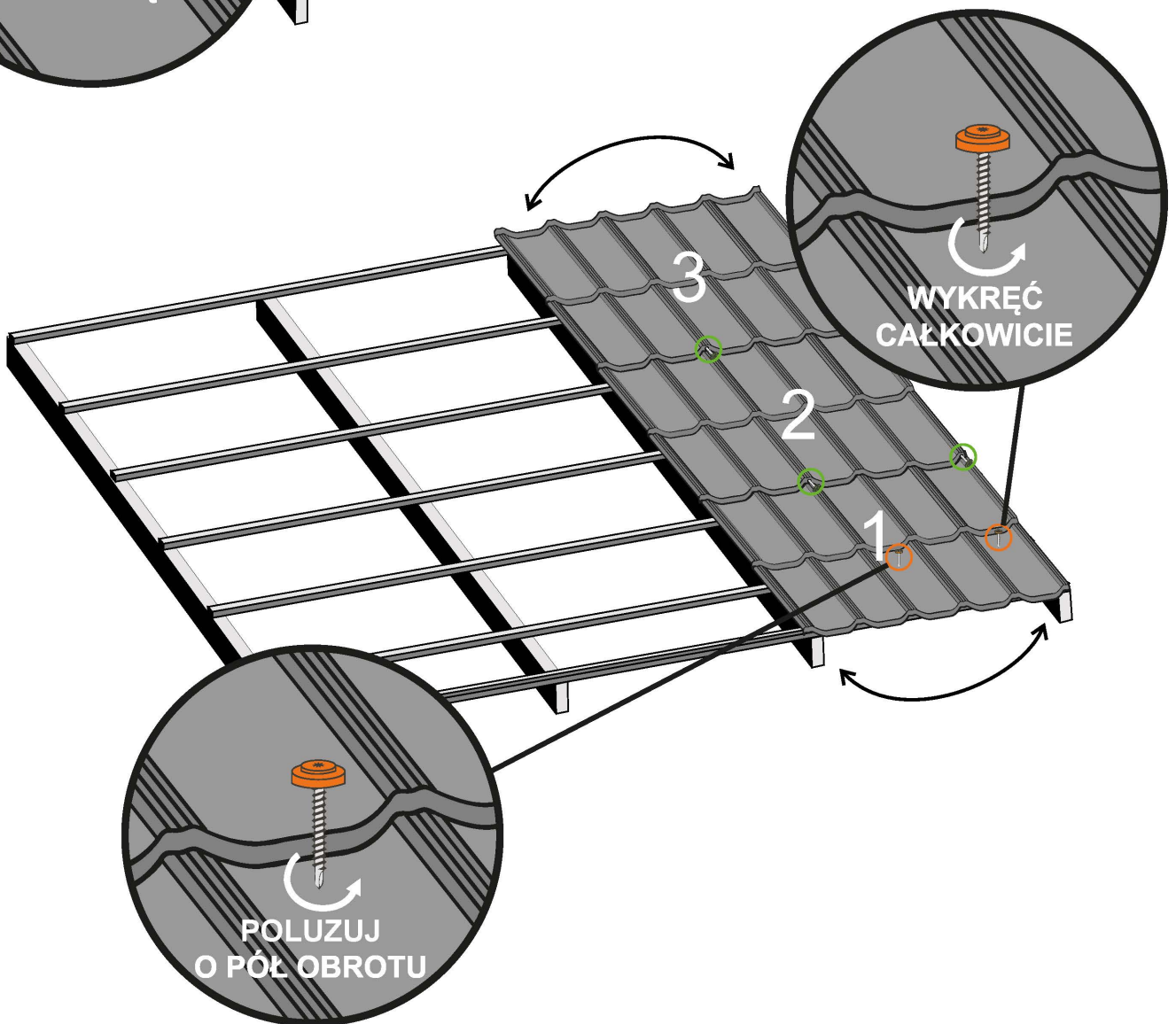
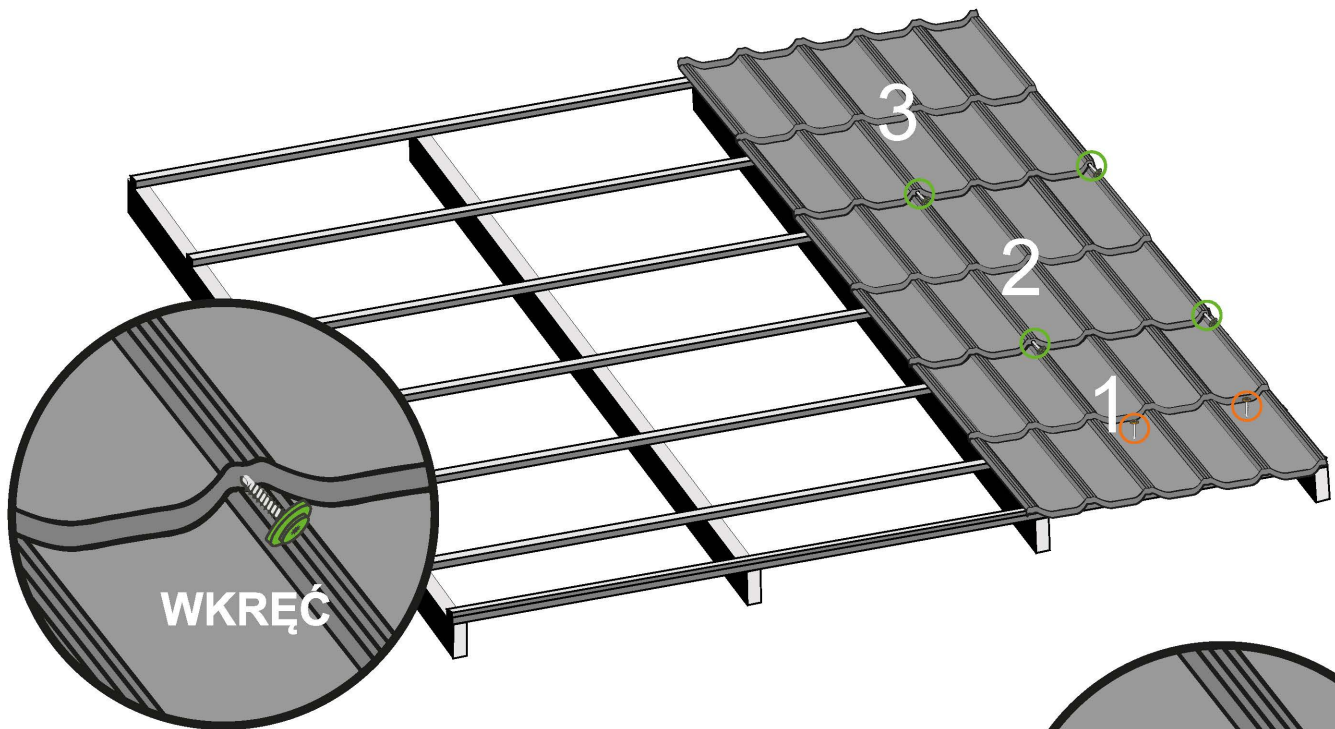
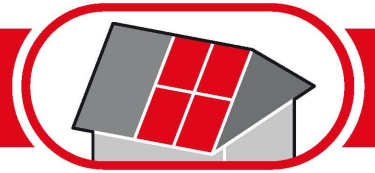

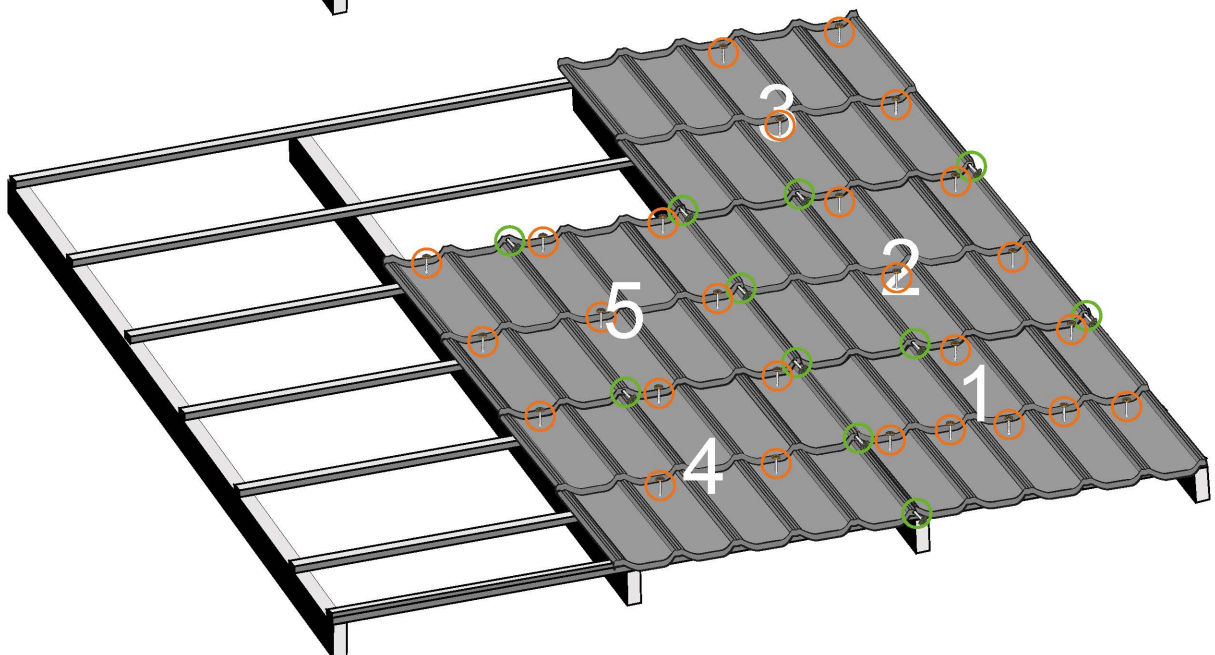
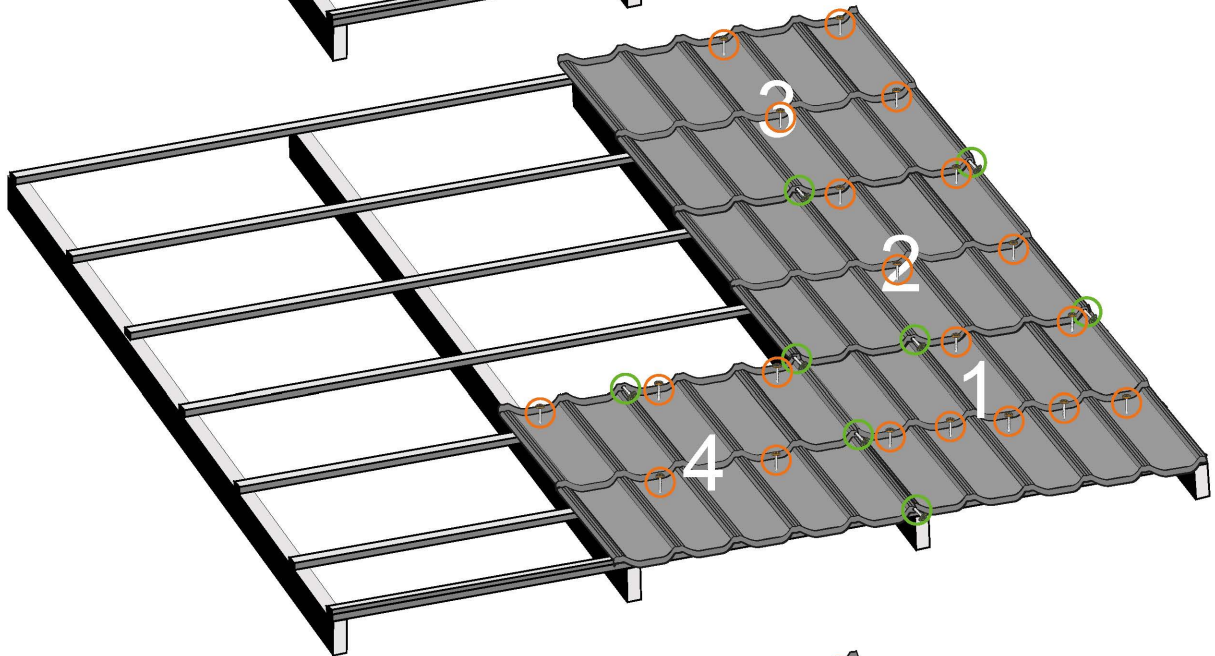
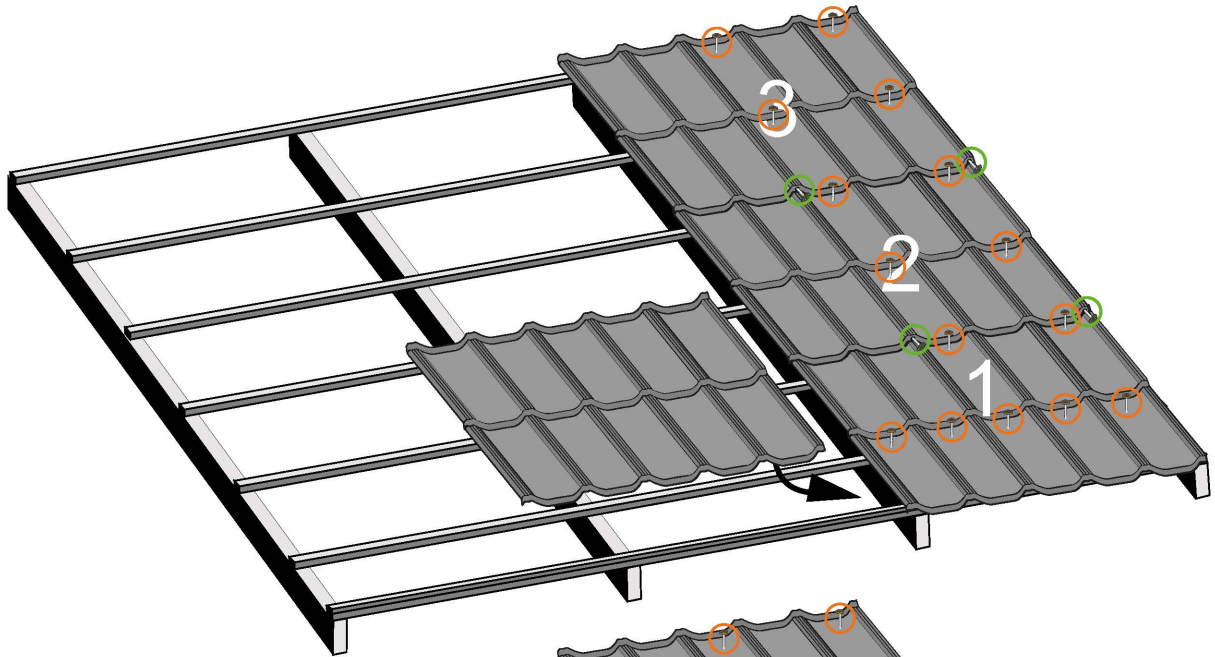
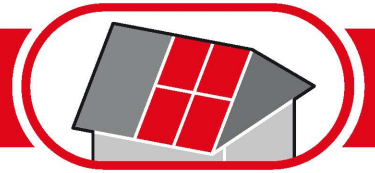

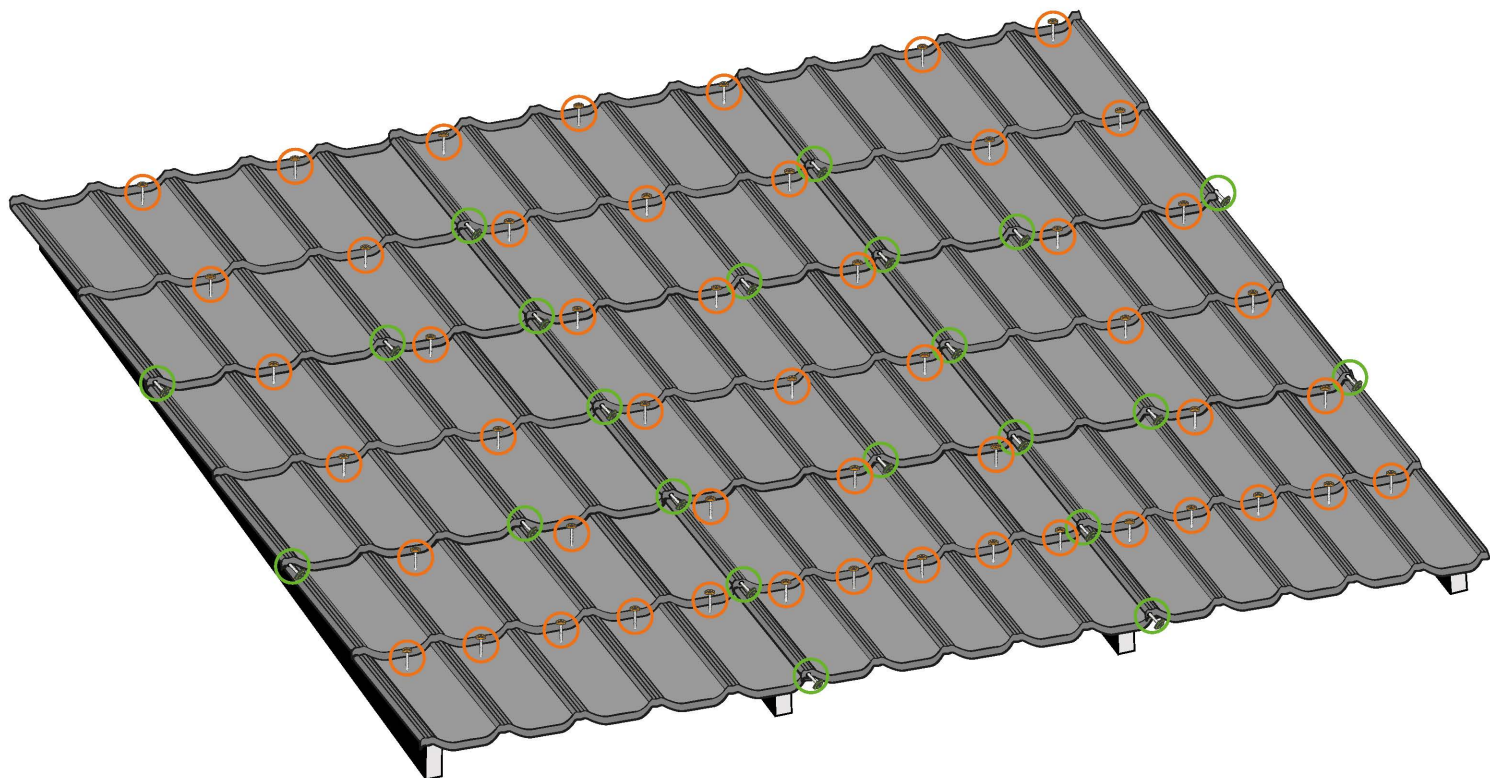
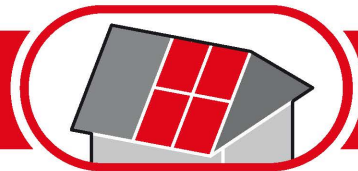

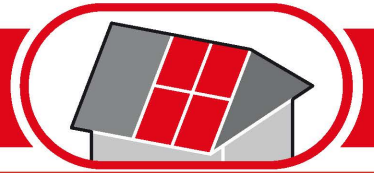

7

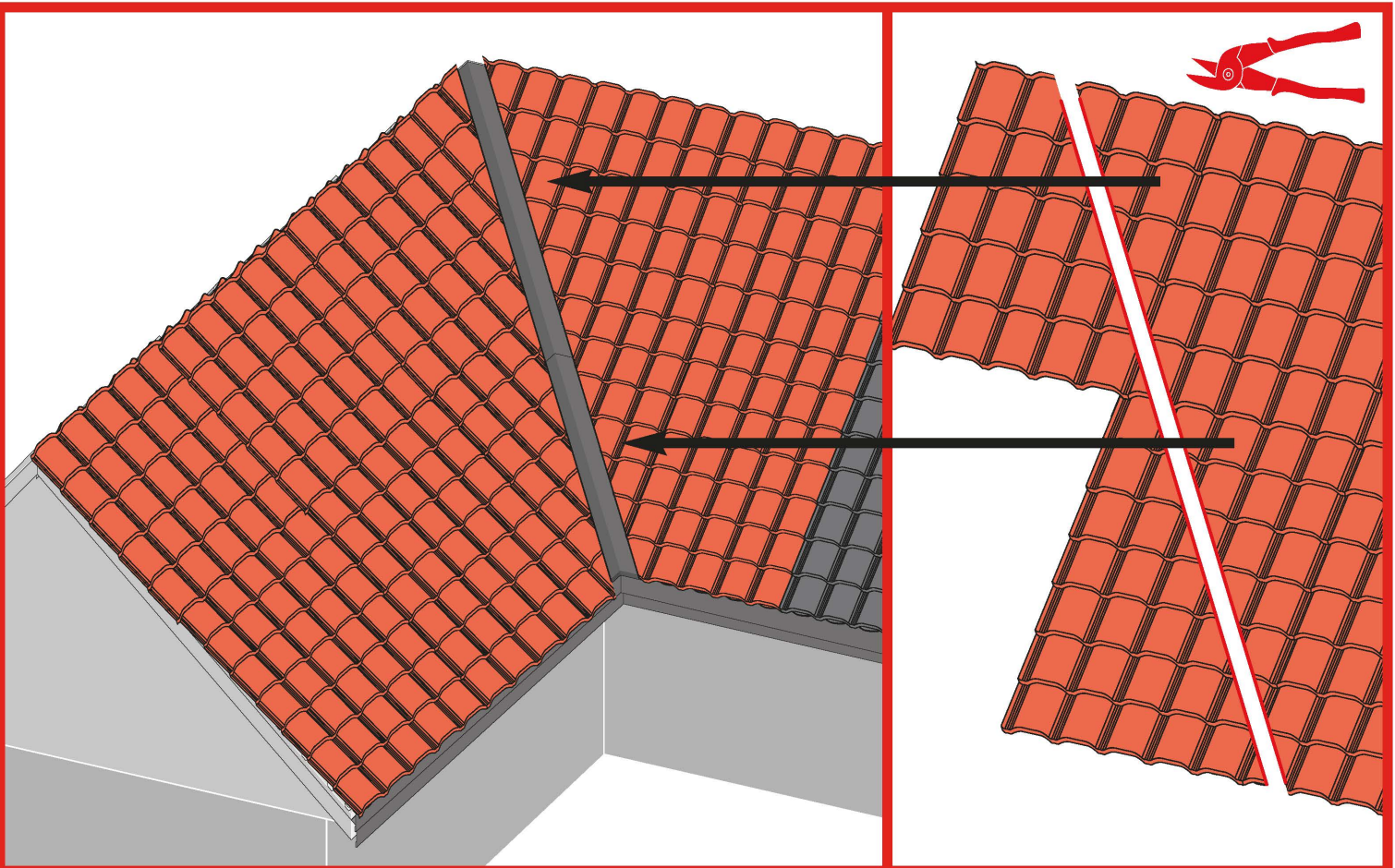
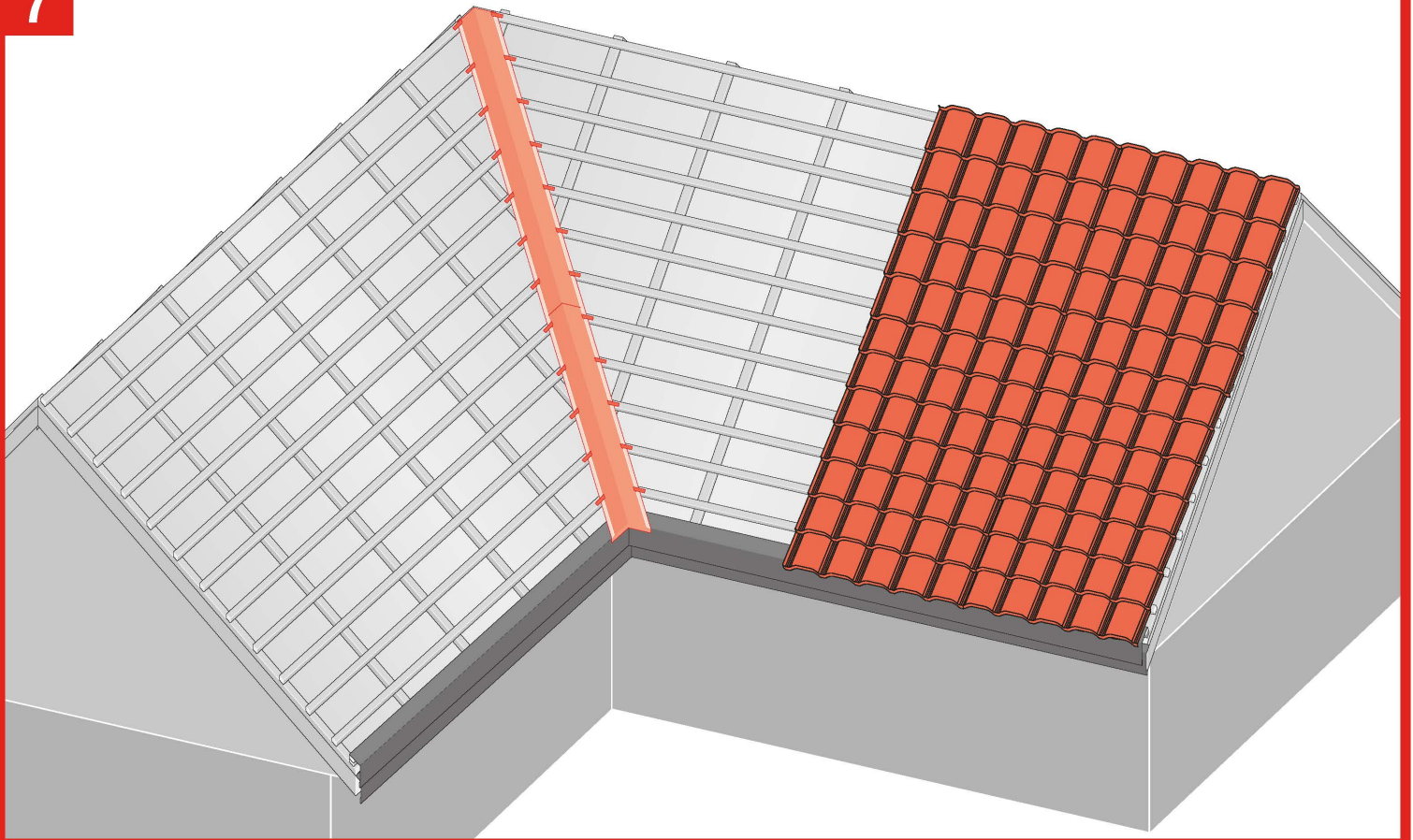

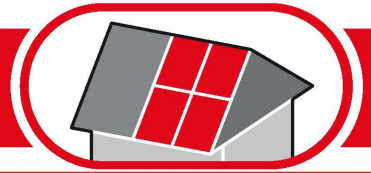

8

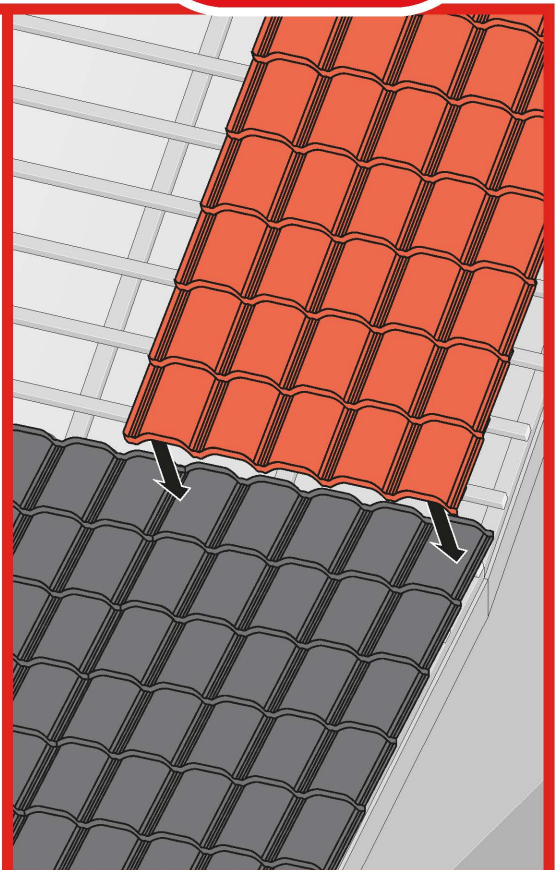
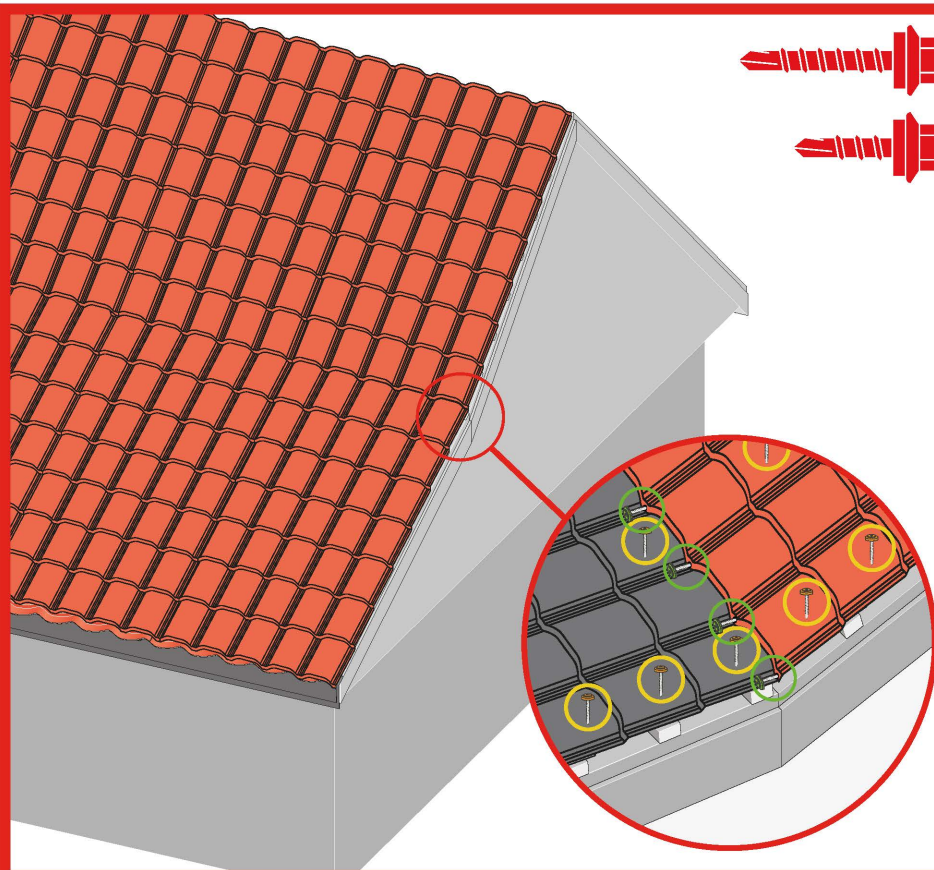
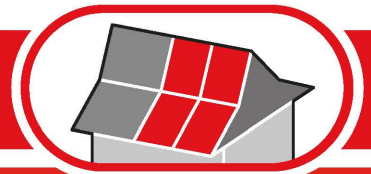
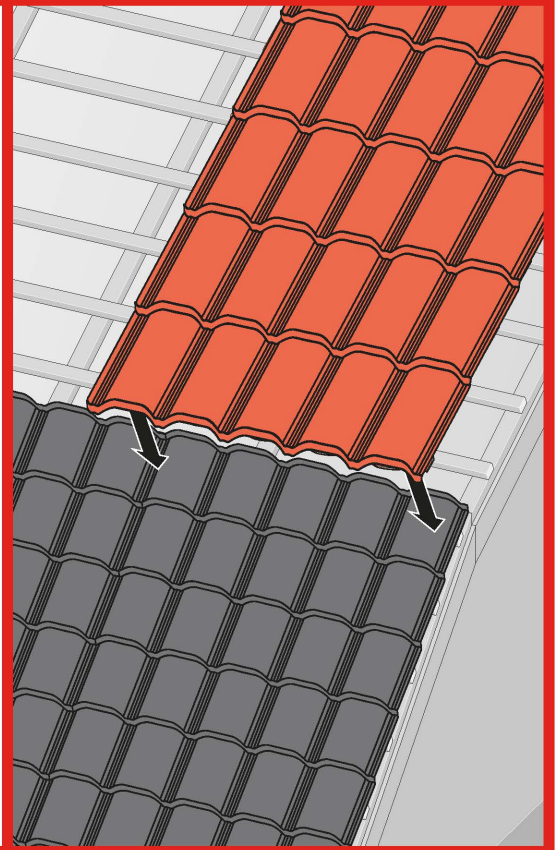
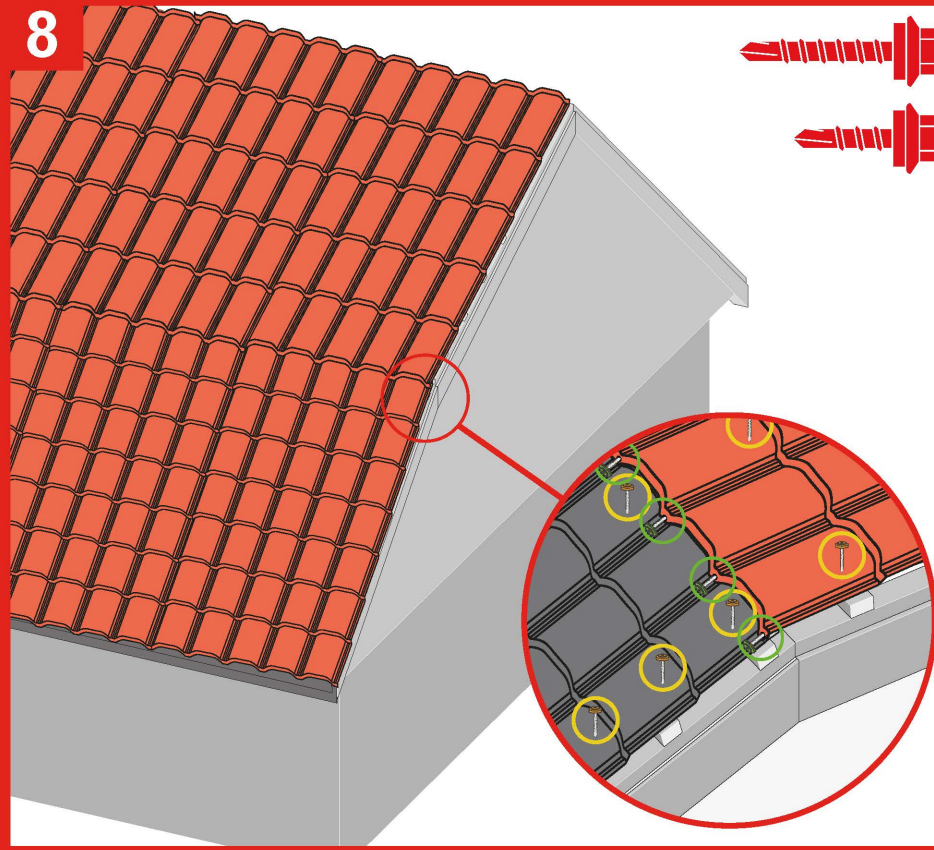

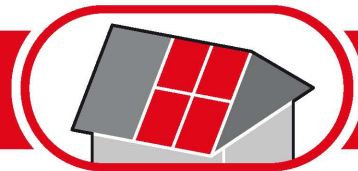

Niniejsza instrukcja jest materiałem poglądowym i nie zwalnia wykonawców z obowiązku przestrzegania zasad sztuki dekarzkiej oraz stosowania się do norm budowlanych. Sposoby montażu przedstawione w tej instrukcji mają charakter wskazówek ogólnych, dlatego różnice w doborze odpowiedniej metody, mogą wynikać z różnego rodzaju dachu i metod krycia w regionie zwłaszcza w przypadku blach nie posiadających rowka kapilarnego, które to mogą wymagać podczas montowania na dachu, dodatkowego uszczelnienia np. taśmą butylową, celem zapobieżenia kapilarnemu podciąganiu wody. Montaż blach dachowych wymaga fachowej wiedzy, praktyki i specjalizacji, dlatego doświadczeni wykonawcy posiadają indywidualne rozwiązania, które firma REGAMET aprobuje.

W celu zapobiegania "jodełkowaniu" zaleca się krycie naprzemienne tj. drugi rząd nakładać na pierwszy, natomiast trzeci podkładać pod drugi.